

 Spares Guide

Medium Voltage Switchgear Products Catalogue



th

Schneider
 Electric

Ferguson
Pailin

1937

Yorkshire
Switchgear



1957

S&C

1967

 Merlin Gerin

1988

GEC ALSTHOM

1994

ALSTOM

1998

AREVA
Distribution

2004

Schneider
Electric
2011

Schneider
Electric

HWX

Evolution of HWX



HWX-old

Total Age= ~20yrs
[1988-2008]

CB → 12kV, 800A-5000A, 44kA
ETX, MTX, UTX, Contactor



HWX-Compact

Total Age= ~6yrs [2008-2014]

CB → 12kV, 800A-2500A, 50kA
ETX, MTX, UTX, Contactor



HWX-S*

Total Age= ~3yrs [2011-2014]

CB → 12kV, 800A-5000A, 50kA
ETX, MTX, UTX, Contactor

Dimensional Comparison in HWX VCB

	Low rating (from 800A to 1600A)			High rating (from 2000A to 5000A)		
	HWX-Old	HWX-C	HWX-S	HWX-Old	HWX-C	HWX-S
A Pole to pole centre	165 mm	165 mm	190 mm	215 mm	215 mm	215 mm
B Top stem to Bottom stem centre	345 mm	345 mm	345 mm	345 mm	345 mm	345 mm
C Floor to Bottom stem centre	811 mm	569 mm	811 mm	811 mm	569 mm	811 mm
D Floor to Racking position centre	496 mm	254 mm	496 mm	496 mm	254 mm	496 mm

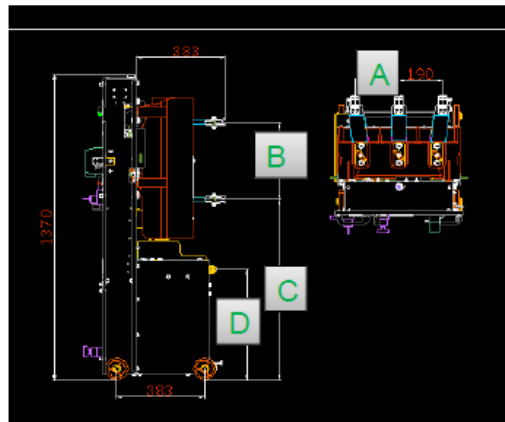
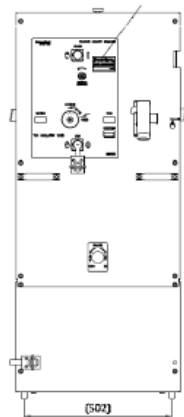

MV Switchgear Spares

Dimensional Comparison in HWX Panel

	Low rating (from 800A to 1600A)			High rating (from 2000A to 5000A)		
	HWX-Old	HWX-C	HWX-S	HWX-Old	HWX-C	HWX-S
A Panel width	660 mm	660 mm	660 mm	860 mm	860 mm	860 mm
B Panel height (with LV chamber)	2430 mm	2118 mm	2400 mm	2430 mm	2118 mm	2400 mm
C Panel depth (w/o extension cable box- 350mm / 500mm)	1797 mm	1625 mm	1715 mm (short BB) 1865 mm (long BB)	1797 mm	1625 mm	1715 mm (short BB) 1865 mm (long BB)

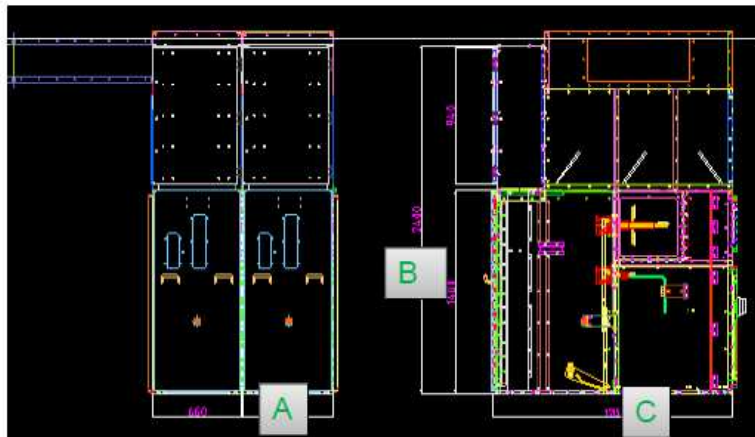

Comparison between HWX-Old, HWX-C and HWX-S VCB

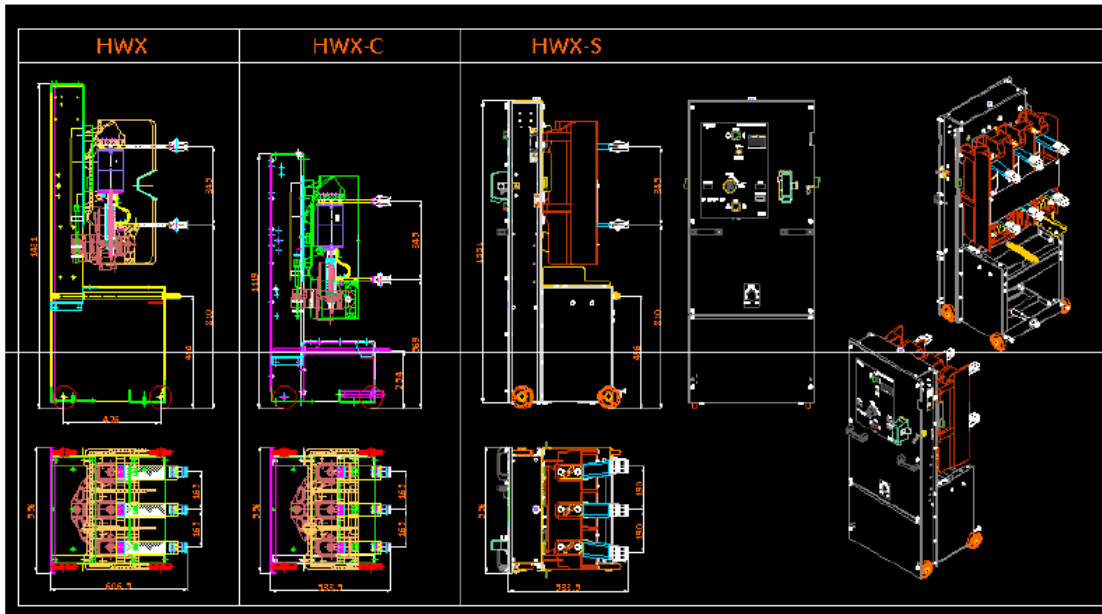

Pole centre distance in HWX-Old and HWX-C = 165mm (in Low rating upto 1600A)

Pole centre distance in HWX-S = 190mm (in Low rating upto 1600A)

Pole centre distance in all variants like HWX-Old, HWX-C and HWX-S for higher rating (above 1600A and upto 5000A) = 215mm

MV Switchgear Spares

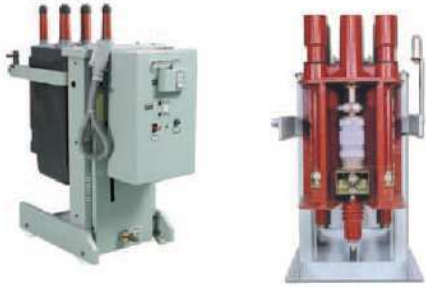

VMX-606



PIX – MV

Cassette Mounted & Floor Rolling CB











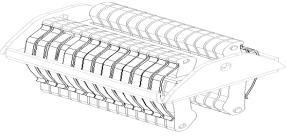
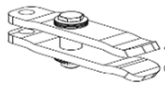
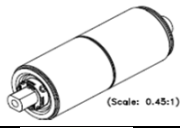

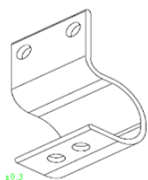
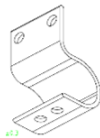
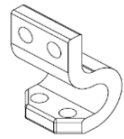
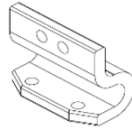
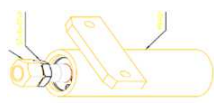
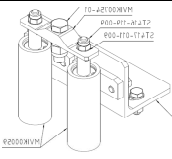

PCOB-36

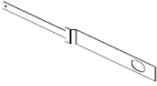
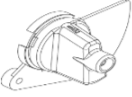
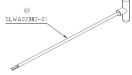

2019 Spares Catalogue

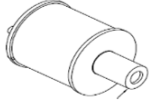
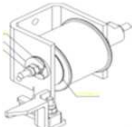
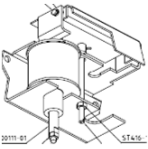

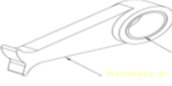

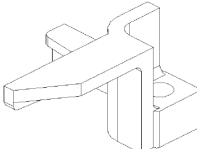
Medium Voltage Switchgear Products

HWX-Old

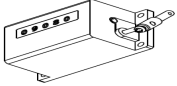
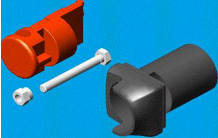
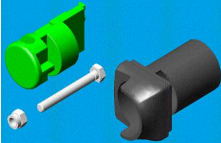
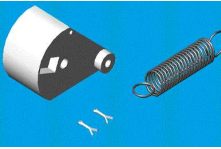
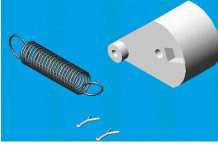
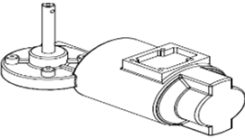
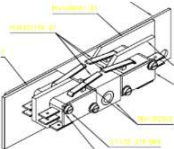
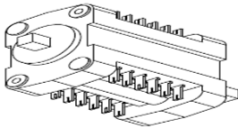
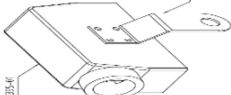
Item Identification	Variants	Discription	Part code	Qty Per VCB (no)	Plant Name	Plant code
ISOLATING CONTACT -FINGER TYPE						
	800A - 2 Pair	ISOLATING CONTACT-800A	MHU39S0523600FN	6	SLW	IN60
	1250A - 3 Pair	ISOLATING CONTACT-1250A	MHU39S0523700FN	6	SLW	IN60
	1600A - 5 Pair (60x16) cross section bus bar	ISOLATING CONTACT-1600A(FOR STEM SIZE-60x16)	MHU39S2044200FN	6	SLW	IN60
	2000A - 5 Pair	ISOLATING CONTACT ASSY-2000A	MHU39S0523800FN	6	SLW	IN60
	2500A/3150A - 7 Pair	ISOLATING CONTACT ASSY FOR 2500A	MVIK00605-01	6	SLW	IN60
ISOLATING CONTACT -FLAT TYPE						
	630 / 800 / 1250A	ISOLATING CONTACT ASSY	MVIK00190-01	12	SLW	IN60
	1600A	ISOLATING CONTACT ASSY	MVIK00190-01	18	SLW	IN60
	2000A	ISOLATING CONTACT ASSY	MVIK00190-02	24	SLW	IN60
	2500/3150A	ISOLATING CONTACT ASSY	MVIK00190-02	36	SLW	IN60
	4000/5000A	ISOLATING CONTACT ASSY	MVIK00190-02	60	SLW	IN60
VACUUM INTERRUPTER						
	VG 2R (Replacement of V207 for VCB Rating up to 1250A)	Complete Vaccum Interrupter VG2-R	QGH49087	3	SLW	IN60
	VG 2	Complete Vaccum Interrupter VG2	DRCVG2002-01	3	SLW	IN60
	VG 3	Complete Vaccum Interrupter VG3	VSLVG3002-01	3	SLW	IN60
	VG 4	Complete Vaccum Interrupter VG4	VSLVG4002-01	3	SLW	IN60
	VG 5	Complete Vaccum Interrupter VG5	DRCVG5002-02	3	SLW	IN60
	FLEXIBLE CONNECTION					
	800A, VG2 / VG2i / VG3	Flexible Connection(800A HWX) (For 800A, 25KA VCB with VG2 TYPE VI)	MVIK00234-02	3	SLW	IN60
	1250A, VG2 / VG2i / VG3	Flexible Connection(1250A HWX) (For 1250A, 25KA VCB with VG2 TYPE VI)	MVIK00235-02	3	SLW	IN60
	800A / 1250A, VG4 (55mm length)	FLEX CONNECTION 800A/1250A. OLD CODE MCU39S3098701FN	SLWD00184-01	3	SLW	IN60
	800A / 1250A, VG4 (64mm length)	FLEX CONNECTION 800A/1250A. OLD CODE MCU39S3098702FN	SLWD00184-02	3	SLW	IN60
	800A / 1250A, VG5	Flex conn.800A/1250A,VG5/WL&1250A V207	MCU39S3098703FN	3	SLW	IN60
	1600A To 3150A, VG3 / VG4 / VG5	FLEX CONNECTION FOR 2000A HWX BREAKER(VG SERIES)	MVIK00822-01	3	SLW	IN60
	1600A, VG5 (115mm - height)	FLEX CONNECTION 1600A,50KA	SLWD00184-04	3	SLW	IN60
	1600A, VG5 (120mm - height)	FLEX CONNECTION 1600A,50KA	SLWD00184-05	3	SLW	IN60
	4000 / 5000A, VG4 / VG5 (50mm - Width)	Flexible Connection 4000/5000A, VG4/VG5	SLWD00136-01	6	SLW	IN60
	4000 / 5000A, VG4 / VG5 (100mm - Width)	Flexible Connection 4000/5000A, VG4/VG5	SLWD00136-02	3	SLW	IN60
OTHER VCB SPARES						
	Dashpot Assembly - Upto 25 kA	Complete Assembly for Dashpot	MHU39S3828900FN	1	SLW	IN60
	Dashpot Assembly (Imported) 31.5KA to 50KA	Dashpot Assembly (Imported) with Bracket	MHU39SMA60000NA	1	SLW	IN60
	Twin Dashpot Assembly 31.5KA to 40KA	TWIN TYPE SHOCK ABSORBER ASSEMBLY	MVIK00726-04	1	SLW	IN60
	Breaker Wheel - Nylon	Wheel - Nylon	MVIA00054-01	4	SLW	IN60

Item Identification	Variants	Discription	Part code	Qty Per VCB (no)	Plant Name	Plant code
	Breaker Wheel - Cast Iron	Cast Iron Wheel with bearing HK12X16	MVIK00025-01	4	SLW	IN60
	Top Guide Roller	Ball Bearing No:6201	MBR39S4323100FN	1	SLW	IN60
	Shutter for Racking Shaft	Shutter for Racking Shaft	MVIJ00016-01	1	SLW	IN60
	Interlock Handle (Dia - 6mm hex) (Dia - 5mm hex is obsolete)for alternate please place order of Interlock handle + Operating handle (Dia- 6mm) + Guide bush together	Interlock Handle	MVIJ00028-01	1	SLW	IN60
	Operating Handle for (Dia - 6mm hex)	HANDLE FOR MANUAL LOCK/FREE ASSY	MNM-39-A0238301	1	SLW	IN60
	Guide Bush	Guide Bush	AGSC72964-01	1	SLW	IN60
RELEASE / CLOSING COIL						
	24 V DC - CN 1346	CLOSING COIL 24 V.DC.(CN 1347)	ECO39SN134600FN	1	SLW	IN60
	30 V DC - CN 1347	RELEASE COIL 30V DC	ECO39SN134700FN	1	SLW	IN60
	50 V DC - CN 1348	CLOSING COIL.50V.DC	ECO39SN134800FN	1	SLW	IN60
	110 V DC - CN 1349	RELEASE COIL 110VDC	ECO39SN134900FN	1	SLW	IN60
	220 V DC - CN 1351	RELEASE COIL 220V DC	ECO39SN135100FN	1	SLW	IN60
SHUNT TRIP COIL						
	24 V DC - CN 1339	TRIP COIL 24V DC.(CN 1339)	ECO39SN133800FN	1	SLW	IN60
	30 V DC - CN 1339	TRIP COIL 30V DC	ECO39SN133900FN	1	SLW	IN60
	48 V DC - CN 1340	TRIP COIL 48VOLT	ECO39SN134000FN	1	SLW	IN60
	110 V DC - CN 1341	TRIP COIL 110VDC	ECO39SN134100FN	1	SLW	IN60
	220 V DC - CN 1343	TRIP COIL 220V.DC	ECO39SN134300FN	1	SLW	IN60
OTHER VCB MECHANISM SPARES						
	RELEASE COIL ASSLY WITH PLUNGER W/O COIL	RELEASE COIL ASSLY WITH PLUNGER W/O COIL	SPR39SASS0008FN_S	1	SLW	IN60
	TRIP COIL BOX ASSY WITH SINGLE PLUNGER W/O COIL	TRIP COIL BOX ASSY WITH SINGLE PLUNGER W/O COIL	SPR39SASS0007FN_S	1	SLW	IN60
	Pin for Release Prop	RELEASE PROP PIN	MVIJ00058-01	1	SLW	IN60
	Charging Pawl with Bush	Release lever assembly	MVIJ00178-01	2	SLW	IN60
	Ratchet Wheel	RATCHET WHEEL ASSEMBLY	MVIE00151-01_S	1	SLW	IN60
	Trip Roller	TRIP ROLLER	MBR27SNAST800NA	1	SLW	IN60
	Motor Cut-off Switch Lever	OPERATING SPRING FOR MICRO SWITCH	MVIJ00027-01	1	SLW	IN60
	Release Lever (Nylon)	MANUAL RELEASE LEVER	MVIJ00010-01	1	SLW	IN60

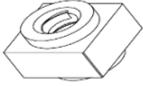

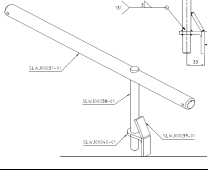
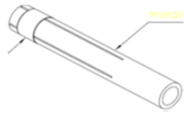
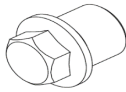
Item Identification	Variants	Discription	Part code	Qty Per VCB (no)	Plant Name	Plant code
	Buffer - Opening Spring	OPENING BUFFER	MVIJ00098-01	1	SLW	IN60
	Buffer - For Closing Spring	BUFFER FOR SPRING	MVIJ00056-01	1	SLW	IN60
	Operation Counter	Operation Counter	MVIJ00172-02	1	SLW	IN60
	Push to Trip Knob (RED) Assembly	Push to Trip Knob (RED) Assembly	SPR39SASS0001FN_S	1	SLW	IN60
	Push to Close Knob (GREEN) Assembly	Push to Close Knob (GREEN) Assembly	SPR39SASS0002FN_S	1	SLW	IN60
	On - Off Indicator Assembly - With Spring	On - Off Indicator Assembly	SPR39SASS0003FN	1	SLW	IN60
	Charge -Free Indicator Assembly-With Spring	Charge -Free Indicator Assembly-With Spring	SPR39SASS0004FN	1	SLW	IN60
Spring Charging Motor with Gear Box Agni make only - (Parvalux make motors are obsolete)						
	110V AC/DC Single Stroke	UNIVERSAL MOTOR WITH GEAR BOX	MVIJ00157-01	1	SLW	IN60
	220V AC/DC Single Stroke	UNIVERSAL MOTOR WITH GEAR BOX	MVIJ00157-02	1	SLW	IN60
	220V AC/DC Multi Stroke	MOTOR FOR MULTI TURN SPRING CHARGING	MVIJ00157-03	1	SLW	IN60
	110V AC/DC Multi Stroke	MOTOR FOR MULTI TURN SPRING CHARGING	MVIJ00157-04	1	SLW	IN60
MOTOR CUT-OFF SWITCH						
	PSRL-R2 2NO+2NC	LIMIT(MICRO) SWITCH WITH 2NO+2NC CONTACT - RIGHT SIDE	ESW-H-ABD00-001	1	SLW	IN60
	PSRL-L2 2NO+2NC	LIMIT(MICRO) SWITCH WITH 2NO+2NC CONTACTS - LEFT SIDE	ESW-H-ABC00-001	1	SLW	IN60
	Micro Switch Assembly	MICRO SWITCH ASSEMBLY FOR HWX MECHANISM	MVU39S0023100SA	1	SLW	IN60
BREAKER AUXILIARY SWITCH						
	12Way Auxiliary Switch (6 NO + 6 NC)	12Way Auxiliary Switch (6 NO + 6 NC)	MVIE00114-01	1	SLW	IN60
	16WayAuxiliary Switch (8 NO + 8 NC)	16WayAuxiliary Switch (8 NO + 8 NC)	MVIE00114-02	1	SLW	IN60
	20 WayAuxiliary Switch (10 NO + 10 NC)	20 WayAuxiliary Switch (10 NO + 10 NC)	MVIJ00186-01	1	SLW	IN60
SECONDARY PLUG & SOCKET COMPONENTS						
	16 Pin Plug & Socket Assembly	16 Pin Plug & Socket Assembly (Double Locking)	MHU39S0009400FN	1	SLW	IN60
	24 Pin Plug & Socket Assembly	24 Pin Plug & Socket Assembly	MHU39S0019000FN	1	SLW	IN60
	32 Pin Plug & Socket Assembly	32 Pin Plug & Socket Assembly	MHU39S0042400FN	1	SLW	IN60
	64 Pin Plug & Socket Assembly	64 Pin Plug & Socket Assembly	MHU39S00196200FN	1	SLW	IN60

Item Identification	Variants	Discription	Part code	Qty Per VCB (no)	Plant Name	Plant code
	Interlock Assembly Components for Secondary Plug & Socket	Interlock Assembly Components for Secondary Plug & Socket	MKT39S0001000CM	1	SLW	IN60
HWX - OLD PANEL COMPONENTS						
BUSBAR CHAMBER ARRANGEMENT						
Bus Bar Spout	3-Phase Busbar Spout for 800A Panel	3-PH B/B SPOUT ASSY FOR 800A, 660 MM PANEL	MEP-39-38627	1	SLW	IN60
	3-Phase Busbar Spout for 1250A Panel	3-PH B/B SPOUT ASSY FOR 1250A, 660 MM PANEL	MEP-39-33583	1	SLW	IN60
	1-Phase Busbar Spout for 1600A / 2000A Panel -R/B Phase	R&B-PH B/B SPOUT ASSY FOR 2000A,860 MM PANEL	MEP-39-34010	2	SLW	IN60
	1-Phase Busbar Spout for 1600A / 2000A Panel -Y Phase	Y-PH B/B SPOUT ASSY FOR 2000A,860 MM PANEL	MEP-39-34009	1	SLW	IN60
	1-Phase Busbar Spout for 2500A/3150A R/B Phase	R&B-PH B/B SPOUT ASSY FOR 2500A / 3150A,860 MM PANEL	MEP-39-38178	2	SLW	IN60
	1-Phase Busbar Spout for 2500A/3150A Y Phase	Y-PH B/B SPOUT ASSY FOR 2500A / 3150A,860 MM PANEL	MEP-39-38179	1	SLW	IN60
	1-Phase BUSBAR SPOUT for 4000/5000A Panel R/B PHASE (Hollow type without fixed copper contact)	1-Phase BUSBAR SPOUT for 4000/5000A Panel R/B PHASE (Hollow type without fixed copper contact)	MEP-39-C0003601	2	SLW	IN60
	1-Phase BUSBAR SPOUT for 4000/5000A Panel Y PHASE (Hollow type without fixed copper contact)	1-Phase BUSBAR SPOUT for 4000/5000A Panel Y PHASE (Hollow type without fixed copper contact)	MEP-39-C0003602	1	SLW	IN60
CT CHAMBER ARRANGEMENT						
Circuit Spout	3-Phase Circuit Spout for 800A Panel	3-Phase Circuit Spout for 800A Panel	MEP-39-38631	1	SLW	IN60
	3-Phase Circuit Spout for 1250A Panel	3-Phase Circuit Spout for 1250A Panel	MEP-39-33989	1	SLW	IN60
	1-Phase Circuit Spout for 1600A / 2000A Panel - R/B Phase	1-Phase Circuit Spout for 1600A / 2000A Panel - R/B Phase	MEP-39-34008	2	SLW	IN60
	1-Phase Circuit Spout for 1600A / 2000A Panel - Y Phase	1-Phase Circuit Spout for 1600A / 2000A Panel - Y Phase	MEP-39-34007	1	SLW	IN60
	1-Phase Circuit Spout for 2500A/3150A Panel R/B Phase	1-Phase Circuit Spout for 2500A/3150A Panel R/B Phase	MEP-39-38180	2	SLW	IN60
	1-Phase Circuit Spout for 2500A/3150A Panel Y Phase	1-Phase Circuit Spout for 2500A/3150A Panel Y Phase	MEP-39-38211	1	SLW	IN60
	1-Phase Circuit Spout for 4000/5000A Panel R/B PHASE (Hollow type without fixed copper contact)	1-Phase Circuit Spout for 4000/5000A Panel R/B PHASE (Hollow type without fixed copper contact)	MEP-39-C0003601	2	SLW	IN60
	1-Phase Circuit Spout for 4000/5000A Panel Y PHASE (Hollow type without fixed copper contact)	1-Phase Circuit Spout for 4000/5000A Panel Y PHASE (Hollow type without fixed copper contact)	MEP-39-C0003602	1	SLW	IN60
	RACKING, SHUTTER AND EARTHING ARRANGEMENT					
	Racking Screw - 660MM PANEL	Racking Screw - 660MM PANEL	SLWD00053-01	1	SLW	IN60
	Racking Screw - 860MM PANEL	Racking Screw - 860MM PANEL	SLWD00053-02	1	SLW	IN60
	Racking Nut - 20MM DIA	Racking Nut - 20MM DIA	MBC-39-32417	1	SLW	IN60
	Rack -In /Rack -Out Socket - Up to 3150A Panel (530mm- Length)	Rack -In /Rack -Out Socket - Up to 3150A Panel (530mm- Length)	MHM-39-347733	1	SLW	IN60
	Rack -In /Rack -Out Socket - 4000/5000A Panel (640MM - Length)	Rack -In /Rack -Out Socket - 4000A / 5000A Panel (640MM - Length)	MHM-39-347734	1	SLW	IN60
	Manual Spring charging socket (530MM - Length)	Manual Spring charging socket (530MM - Length)	MHM-39-347732	1	SLW	IN60
	Racking and Spring Charging Handle shaft	Racking and Spring Charging Handle shaft	MHM-39-347731	1	SLW	IN60
	Earthing Truck/Earthing Switch operating handle	Earthing Truck/Earthing Switch operating handle	SLWJ00041-01	1	SLW	IN60
	Earthing Socket	Earthing Socket	MVIK00139-01	1	SLW	IN60
	Earthing Nut	Earthing Nut	MVIK00023-01	1	SLW	IN60
	Shutter Assembly For Busbar/ Circuit Spout - 660 (Alu-Zn sheet)	Shutter Assembly For Busbar/ Circuit Spout - 660 (Alu-Zn sheet)	SPP0009-03	1	SLW	IN60
	Shutter Assembly For Busbar/ Circuit Spout - 860 (Alu-Zn sheet)	Shutter Assembly For Busbar/ Circuit Spout - 860 (Alu-Zn sheet)	SPP0009-04	1	SLW	IN60



Item Identification	Variants	Discription	Part code	Qty Per VCB (no)	Plant Name	Plant code
	Shutter Assembly For Busbar/ Circuit Spout - 860 - 4000A (Alu-Zn sheet)	Shutter Assembly For Busbar/ Circuit Spout - 860 - 4000A (Alu-Zn sheet)	SPP0009-05	1	SLW	IN60
POTENTIAL TRANSFORMER (FUSE)						
	HRC Fuse-PT HT Side VTF-11, 3A	HRC Fuse-PT HT Side VTF-11, 3A	EHF-A-EV000-001	3	SLW	IN60
	HRC Fuse-PT HT Side VTF 6.6, 3A	HRC Fuse-PT HT Side VTF 6.6, 3A	EHF-B-BBA00-001	2	SLW	IN60
OTHER						
	Limit Switch-1NO+1NC - Service/Test Position	Limit Switch-1NO+1NC - Service/Test Position	ESW-B-AAA00-001	8	SLW	IN60
	RECTIFIER 16A,1000P MONOBLOCK	RECTIFIER 16A,1000P MONOBLOCK	ERC-A-A00DC-001	1	SLW	IN60
	Busbar Support Insulator - 40KA	Busbar Support Insulator - 40KA	MEP-39-A0147901	x	SLW	IN60
	Busbar Support Insulator - 25KA	Busbar Support Insulator - 25KA	MEP-27-30370B	x	SLW	IN60
	Thermostat For Space Heater	Thermostat For Space Heater	ETH-E-B0000-001	1	SLW	IN60
	Space Heater	Space Heater	EHT-A-AA000-001	1	SLW	IN60

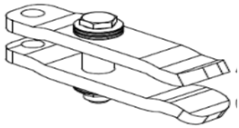

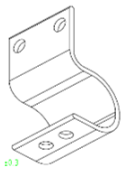



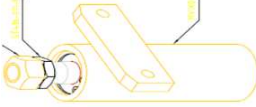
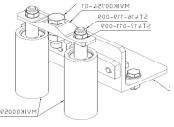
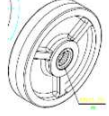

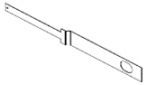
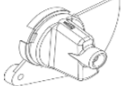
Note:- Shutter Assembly components ordering as per MOQ -10 nos(Min)

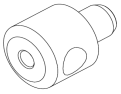
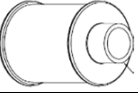
HWX-C

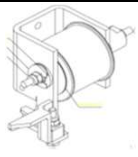
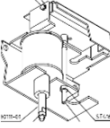
Item Identification	Variants	Discription	Part code	Qty Per VCB	Plant Name	Plant code
ISOLATING CONTACT -FLAT TYPE						
	800A / 1250A	ISOLATING CONTACT ASSY	MVIK00190-01	12	SLW	IN60
	1600A	ISOLATING CONTACT ASSY	MVIK00190-01	18	SLW	IN60
	2000A	ISOLATING CONTACT ASSY	MVIK00190-02	24	SLW	IN60
	2500/3150A	ISOLATING CONTACT ASSY	MVIK00190-02	36	SLW	IN60
VACUUM INTERRUPTER						
	VG 2	Complete Vaccum Interrupter VG2	DRCVG2002-01	3	SLW	IN60
	VG 3	Complete Vaccum Interrupter VG3	VSLVG3002-01	3	SLW	IN60
	VG 4	Complete Vaccum Interrupter VG4	VSLVG4002-01	3	SLW	IN60
FLEXIBLE CONNECTION						
	Flexible Connection 800A, VG2/VG2i/VG3	Flexible Connection(800A HWX) (For 800A, 25KA VCB with VG2 TYPE VI)	MVIK00234-02	3	SLW	IN60
	Flexible Connection 1250A, VG2/VG2i/VG3	Flexible Connection(1250A HWX) (For 1250A, 25KA VCB with VG2 TYPE VI)	MVIK00235-02	3	SLW	IN60
	Flexible Connection 1600A To 3150A, VG3 / VG4	FLEX CONNECTION FOR 2000A HWX BREAKER(VG SERIES)	MVIK00822-01	3	SLW	IN60
	Flexible Connection 1600A, VG5 (115mm - height)	FLEX CONNECTION 1600A,50KA	SLWD00184-04	3	SLW	IN60
	Flexible Connection 1600A, VG5 (120mm - height)	FLEX CONNECTION 1600A,50KA	SLWD00184-05	3	SLW	IN60

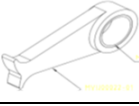
OTHER VCB SPARES

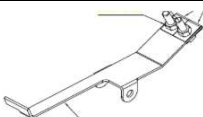
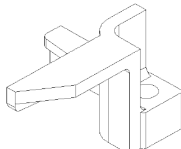
	Dashpot Assembly - Upto 25 kA	Complete Assembly for Dashpot	MHU39S3828900FN	1	SLW	IN60
	Dashpot Assembly (Imported) 31.5KA to 50KA	Dashpot Assembly (Imported) with Bracket	MHU39SMA60000NA	1	SLW	IN60
	Twin Dashpot Assembly 31.5KA to 40KA	TWIN TYPE SHOCK ABSORBER ASSEMBLY	MVIK00726-04	1	SLW	IN60
	Breaker Wheel - Nylon	Wheel - Nylon	MVIA00054-01	4	SLW	IN60
	Breaker Wheel - Cast Iron	Cast Iron Wheel with bearing HK12X16	MVIK00025-01	4	SLW	IN60
	Top Guide Roller	Ball Bearing No:6201	MBR39S4323100FN	1	SLW	IN60
	Shutter for Racking Shaft	Shutter for Racking Shaft	MVIJ00016-01	1	SLW	IN60
	Interlock Handle (Dia - 6mm hex) (Dia - 5mm hex is obsolete)for alternate please place order of Interlock handle + Operating handle (Dia- 6mm) + Guide bush together	Interlock Handle	MVIJ00028-01	1	SLW	IN60

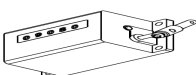
Item Identification	Variants	Discription	Part code	Qty Per VCB (no)	Plant Name	Plant code
	Operating Handle for (Dia - 6mm hex)	HANDLE FOR MANUAL LOCK/FREE ASSY	MNM-39-A0238301	1	SLW	IN60
	Guide Bush	Guide Bush	AGSC72964-01	1	SLW	IN60
RELEASE / CLOSING COIL						
	24 V DC - CN 1346	CLOSING COIL 24 V.DC.(CN 1347)	ECO39SN134600FN	1	SLW	IN60
	30 V DC - CN 1347	RELEASE COIL 30V DC	ECO39SN134700FN	1	SLW	IN60
	50 V DC - CN 1348	CLOSING COIL 50V.DC	ECO39SN134800FN	1	SLW	IN60
	110 V DC - CN 1349	RELEASE COIL 110VDC	ECO39SN134900FN	1	SLW	IN60
	220 V DC - CN 1351	RELEASE COIL 220V DC	ECO39SN135100FN	1	SLW	IN60
SHUNT TRIP COIL						
	24 V DC - CN 1339	TRIP COIL 24V DC.(CN 1339)	ECO39SN133800FN	1	SLW	IN60
	30 V DC - CN 1339	TRIP COIL 30V DC	ECO39SN133900FN	1	SLW	IN60
	48 V DC - CN 1340	TRIP COIL 48VOLT	ECO39SN134000FN	1	SLW	IN60
	110 V DC - CN 1341	TRIP COIL 110VDC	ECO39SN134100FN	1	SLW	IN60
	220 V DC - CN 1343	TRIP COIL 220V.DC	ECO39SN134300FN	1	SLW	IN60
OTHER VCB MECHANISM SPARES						
	RELEASE COIL ASSLY WITH PLUNGER W/O COIL	RELEASE COIL ASSLY WITH PLUNGER W/O COIL	SPR39SASS0008FN_S	1	SLW	IN60
	TRIP COIL BOX ASSY WITH SINGLE PLUNGER W/O COIL	TRIP COIL BOX ASSY WITH SINGLE PLUNGER W/O COIL	SPR39SASS0007FN_S	1	SLW	IN60
	Pin for Release Prop	RELEASE PROP PIN	MVIJ00058-01	1	SLW	IN60
	Charging Pawl with Bush	Release lever assembly	MVIJ00178-01	2	SLW	IN60
	Ratchet Wheel	RATCHET WHEEL ASSEMBLY	MVIE00151-01_S	1	SLW	IN60
	Trip Roller	TRIP ROLLER	MBR27SNAST800NA	1	SLW	IN60
	Motor Cut-off Switch Lever	OPERATING SPRING FOR MICRO SWITCH	MVIJ00027-01	1	SLW	IN60
	Release Lever (Nylon)	MANUAL RELEASE LEVER	MVIJ00010-01	1	SLW	IN60
	Buffer - Opening Spring	OPENING BUFFER	MVIJ00098-01	1	SLW	IN60
	Buffer - For Closing Spring	BUFFER FOR SPRING	MVIJ00056-01	1	SLW	IN60
	Operation Counter	Operation Counter	MVIJ00172-02	1	SLW	IN60

Item Identification	Variants	Discription	Part code	Qty Per VCB (no)	Plant Name	Plant code
	Push to Trip Knob (RED) Assembly	Push to Trip Knob (RED) Assembly	SPR39SASS0001FN_S	1	SLW	IN60
	Push to Close Knob (GREEN) Assembly	Push to Close Knob (GREEN) Assembly	SPR39SASS0002FN_S	1	SLW	IN60
	On - Off Indicator Assembly - With Spring	On - Off Indicator Assembly	SPR39SASS0003FN	1	SLW	IN60
	Charge -Free Indicator Assembly-With Spring	Charge -Free Indicator Assembly-With Spring	SPR39SASS0004FN	1	SLW	IN60
Spring Charging Motor with Gear Box Agni make only - (Parvalux make motors are obsolete)						
	110V AC/DC Single Stroke	UNIVERSAL MOTOR WITH GEAR BOX	MVJ00157-01	1	SLW	IN60
	220V AC/DC Single Stroke	UNIVERSAL MOTOR WITH GEAR BOX	MVJ00157-02	1	SLW	IN60
	220V AC/DC Multi Stroke	MOTOR FOR MULTI TURN SPRING CHARGING	MVJ00157-03	1	SLW	IN60
	110V AC/DC Multi Stroke	MOTOR FOR MULTI TURN SPRING CHARGING	MVJ00157-04	1	SLW	IN60
MOTOR CUT-OFF SWITCH						
	PSRL-R2 2NO+2NC	LIMIT(MICRO) SWITCH WITH 2NO+2NC CONTACT - RIGHT SIDE	ESW-H-ABD00-001	1	SLW	IN60
	PSRL-L2 2NO+2NC	LIMIT(MICRO) SWITCH WITH 2NO+2NC CONTACTS - LEFT SIDE	ESW-H-ABC00-001	1	SLW	IN60
	Micro Switch Assembly	MICRO SWITCH ASSEMBLY FOR HWX MECHANISM	MVU39S0023100SA	1	SLW	IN60
BREAKER AUXILIARY SWITCH						
	12Way Auxiliary Switch (6 NO + 6 NC)	12Way Auxiliary Switch (6 NO + 6 NC)	MVIE00114-01	1	SLW	IN60
	16WayAuxiliary Switch (8 NO + 8 NC)	16WayAuxiliary Switch (8 NO + 8 NC)	MVIE00114-02	1	SLW	IN60
	20 WayAuxiliary Switch (10 NO + 10 NC)	20 WayAuxiliary Switch (10 NO + 10 NC)	MVJ00186-01	1	SLW	IN60
SECONDARY PLUG & SOCKET COMPONENTS						
	16 Pin Plug & Socket Assembly	16 Pin Plug & Socket Assembly (Double Locking)	MHU39S0009400FN	1	SLW	IN60
	24 Pin Plug & Socket Assembly	24 Pin Plug & Socket Assembly	MHU39S0019000FN	1	SLW	IN60
	32 Pin Plug & Socket Assembly	32 Pin Plug & Socket Assembly	MHU39S0042400FN	1	SLW	IN60
	64 Pin Plug & Socket Assembly	64 Pin Plug & Socket Assembly	MHU39S00196200FN	1	SLW	IN60
	Interlock Assembly Components for Secondary Plug & Socket	Interlock Assembly Components for Secondary Plug & Socket	MKT39S0001000CM	1	SLW	IN60
HWX - C PANEL COMPONENTS						
BUSBAR CHAMBER ARRANGEMENT						
	1-Phase Busbar Spout for 800/1250A Panel - R/B Phase	1-Phase Busbar Spout for 800/1250A Panel - R/B Phase	MEP-39-32185	2	SLW	IN60

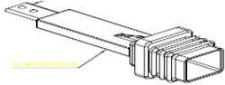
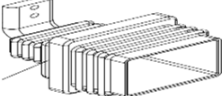
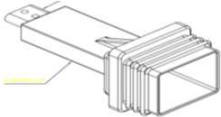
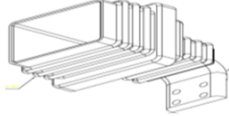
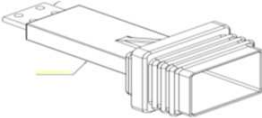
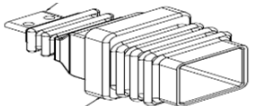
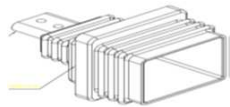
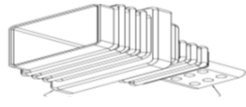
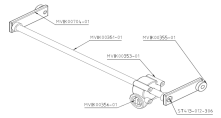
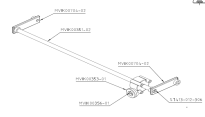
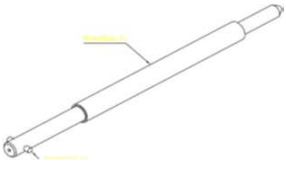
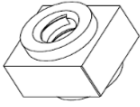
Item Identification	Variants	Discription	Part code	Qty Per VCB (no)	Plant Name	Plant code
	1-Phase Busbar Spout for 800/1250A Panel - Y Phase	1-Phase Busbar Spout for 800/1250A Panel - Y Phase	MEP-39-32186	1	SLW	IN60
	1-Phase Busbar Spout for 1600/2000A Panel - R/B Phase	1-Phase Busbar Spout for 1600/2000A Panel - R/B Phase	MEP-39-A0051301	10	SLW	IN60
	1-Phase Busbar Spout for 1600/2000A Panel - Y Phase	1-Phase Busbar Spout for 1600/2000A Panel - Y Phase	MEP-39-A0051401	10	SLW	IN60
	1-Phase Busbar Spout for 2500A Panel - R/B Phase	1-Phase Busbar Spout for 2500A Panel - R/B Phase	MEP-39-A0051302	10	SLW	IN60
	1-Phase Busbar Spout for 2500A Panel - Y Phase	1-Phase Busbar Spout for 2500A Panel - Y Phase	MEP-39-A0051402	1	SLW	IN60
CT CHAMBER ARRANGEMENT (MENTION PANEL SERIAL NO.)						
	1-Phase Circuit Spout for 800A/1250A Panel - R/Y/B Phase	1-Phase Circuit Spout for 800A/1250A Panel - R/Y/B Phase	MEP-39-32187	3	SLW	IN60
	1-Phase Circuit Spout for 1600A/2000A Panel - R/Y/B Phase	1-Phase Circuit Spout for 1600A/2000A Panel - R/Y/B Phase	MEP-39-A0164301	3	SLW	IN60
	1-Phase Circuit Spout for 2500A Panel - R/Y/B Phase	1-Phase Circuit Spout for 2500A Panel - R/Y/B Phase	MEP-39-A0164302	3	SLW	IN60
RACKING, SHUTTER AND EARTHING ARRANGEMENT						
	RACKING ARRANGEMENT ASSLY FOR HWX-C(660W)	RACKING ARRANGEMENT ASSLY FOR (660W)	MVIK00296-01	1	SLW	IN60
	RACKING ARRANGEMENT ASSLY FOR HWX-C(860W)	RACKING ARRANGEMENT ASSLY FOR (860W)	MVIK00296-02	1	SLW	IN60
	Short Racking Screw-20 dia for 660W	Short Racking Screw-20 dia for 660W	MVIK00026-02	1	SLW	IN60
	Short Racking Screw-20 dia for 860W	Short Racking Screw-20 dia for 860W		1	SLW	IN60
	Racking Nut - 20 dia	Racking Nut - 20 dia	MBC-39-32417	1	SLW	IN60
	Racking Nut - 30 dia	Racking Nut - 30 dia	MNM-39-A0115701	1	SLW	IN60
	Rack -In /Rack -Out Handle / Motor Charging handle - Up to 2500A Panel	Rack -In /Rack -Out Handle / Motor Charging handle - Up to 2500A Panel	MNM-39-41920	1	SLW	IN60

Item Identification	Variants	Discription	Part code	Qty Per VCB (no)	Plant Name	Plant code
	Earthing Socket	Earthing Socket	MVIK00139-01	1	SLW	IN60
	Earthing Nut	Earthing Nut	MVIK00023-01	1	SLW	IN60
	Shutter Assembly For Busbar/ Circuit Spout - 660 (Alu-Zn sheet)	Shutter Assembly For Busbar/ Circuit Spout - 660 (Alu-Zn sheet)	SPP0009-01	1	SLW	IN60
	Shutter Assembly For Busbar/ Circuit Spout - 860 (Alu-Zn sheet)	Shutter Assembly For Busbar/ Circuit Spout - 860 (Alu-Zn sheet)	SPP0009-02	1	SLW	IN60

POTENTIAL TRANSFORMER (FUSE)						
	HRC Fuse-PT HT Side VTF-11, 3A	HRC Fuse-PT HT Side VTF-11, 3A	EHF-A-EV000-001	3	SLW	IN60
	HRC Fuse-PT HT Side VTF 6.6, 3A	HRC Fuse-PT HT Side VTF 6.6, 3A	EHF-B-BBA00-001	2	SLW	IN60

OTHER						
	Limit Switch-1NO+1NC - Service/Test Position	Limit Switch-1NO+1NC - Service/Test Position	ESW-B-AAA00-001	8	SLW	IN60
	RECTIFIER 16A,1000P MONOBLOCK	RECTIFIER 16A,1000P MONOBLOCK	ERC-A-A00DC-001	1	SLW	IN60
	Busbar Support Insulator - 40KA	Busbar Support Insulator - 40KA	MEP-39-A0147901	x	SLW	IN60
	Busbar Support Insulator - 25KA	Busbar Support Insulator - 25KA	MEP-27-30370B	x	SLW	IN60
	Thermostat For Space Heater	Thermostat For Space Heater	ETH-E-B0000-001	1	SLW	IN60
	Space Heater	Space Heater	EHT-A-AA000-001	1	SLW	IN60

HWX-S



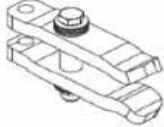
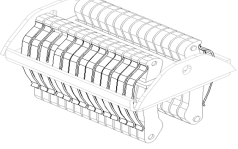

Item Identification	Variants	Discription	Part code	Qty Per VCB	Plant Name	Plant code
---------------------	----------	-------------	-----------	-------------	------------	------------

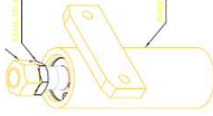
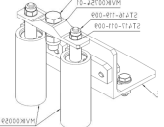
Isolating contacts						
	Isolating contacts Flat Type - 1250A	ISOLATING CONTACT ASSY	MVIK00190-01	12	SLW	IN60
	Isolating contacts Flat Type - 1600A	ISOLATING CONTACT ASSY	MVIK00190-01	18	SLW	IN60
	Isolating contacts Flat Type - 2000A	ISOLATING CONTACT ASSY	MVIK00190-02	24	SLW	IN60
	Isolating contacts - 2500A Finger Type- 7 Pair	Isolating contacts - 2500A Finger Type- 7 Pair	MVIK00605-01	6	SLW	IN60
	Isolating contacts - 2700A Finger Type - 9 Pair	Isolating contacts - 2700A Finger Type - 9 Pair	MVIK00605-02	6	SLW	IN60
	Isolating contacts - 4000A Finger Type - 7 Pair	Isolating contacts - 4000A Finger Type - 7 Pair	MVIK00605-01	12	SLW	IN60



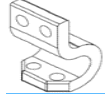
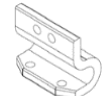





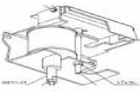

Shock absorber						
----------------	--	--	--	--	--	--



	Dashpot Assembly - Upto 25 kA	Complete Assembly for Dashpot	MHU39S3828900FN	1	SLW	IN60
	Dashpot Assembly (Imported) 31.5KA to 50KA	Dashpot Assembly (Imported) with Bracket	MHU39SMA60000NA	1	SLW	IN60
	Twin Dashpot Assembly 31.5KA to 40KA	TWIN TYPE SHOCK ABSORBER ASSEMBLY	MVIK00726-04	1	SLW	IN60

Conductors						
------------	--	--	--	--	--	--

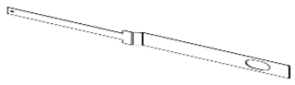
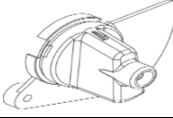
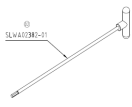
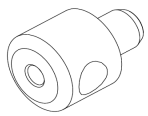

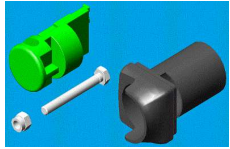
	4000 / 5000A, VG4 / VG5 (50mm - Width)	Flexible Connection 4000/5000A, VG4/VG5	SLWD00136-01	6	SLW	IN60
	4000 / 5000A, VG4 / VG5 (100mm - Width)	Flexible Connection 4000/5000A, VG4/VG5	SLWD00136-02	3		
	1600A To 3150A, VG3 / VG4 / VG5	FLEX CONNECTION FOR 2000A HWX BREAKER(VG SERIES)	MVIK00822-01	3	SLW	IN60
	1600A, VG5 (120mm - height)	FLEX CONNECTION 1600A,50KA	SLWD00184-05	3	SLW	IN60
	1600A, VG5 (115mm - height)	FLEX CONNECTION 1600A,50KA	SLWD00184-04	3	SLW	IN60
	800A / 1250A, VG4 (55mm length)	FLEX CONNECTION 800A/1250A. OLD CODE MCU39S3098701FN	SLWD00184-01	3	SLW	IN60

Item Identification	Variants	Discription	Part code	Qty Per VCB (no)	Plant Name	Plant code
	800A / 1250A, VG4 (64mm length)	FLEX CONNECTION 800A/1250A. OLD CODE MCU39S3098702FN	SLWD00184-02	3	SLW	IN60
	1250A, VG2 / VG2i / VG3	Flexible Connection(1250A HWX) (For 1250A, 25KA VCB with VG2 TYPE VI)	MVIK00235-02	3	SLW	IN60
	800A, VG2 / VG2i / VG3	Flexible Connection(800A HWX) (For 800A, 25KA VCB with VG2 TYPE VI)	MVIK00234-02	3	SLW	IN60
Vacuum Interrupter						
	VG 2	Complete Vaccum Interrupter VG2	DRCVG2002-01	3	SLW	IN60
	VG 3	Complete Vaccum Interrupter VG3	VSLVG3002-01	3	SLW	IN60
	VG 4	Complete Vaccum Interrupter VG4	VSLVG4002-01	3	SLW	IN60
	VG 5	Complete Vaccum Interrupter VG5	DRCVG5002-02	3	SLW	IN60
Operating Mechanism						
	Micro Switch Assembly	MICRO SWITCH ASSEMBLY FOR HWX MECHANISM	MVU39S0023100SA	1	SLW	IN60
	12Way Auxiliary Switch (6 NO + 6 NC)	12Way Auxiliary Switch (6 NO + 6 NC)	MVIE00114-01	1	SLW	IN60
	16WayAuxiliary Switch (8 NO + 8 NC)	16WayAuxiliary Switch (8 NO + 8 NC)	MVIE00114-02	1	SLW	IN60
	20 WayAuxiliary Switch (10 NO + 10 NC)	20 WayAuxiliary Switch (10 NO + 10 NC)	MVIJ00186-01	1	SLW	IN60
	Trip Roller	TRIP ROLLER	MBR27SNAST800NA	1	SLW	IN60
	Ratchet Wheel	RATCHET WHEEL ASSEMBLY	MVIE00151-01_S	1	SLW	IN60
	Pin for Release Prop	RELEASE PROP PIN	MVIJ00058-01	1	SLW	IN60
	Release Lever (Nylon)	MANUAL RELEASE LEVER	MVIJ00010-01	1	SLW	IN60
	Buffer - Opening Spring	OPENING BUFFER	MVIJ00098-01	1	SLW	IN60
	Buffer - For Closing Spring	BUFFER FOR SPRING	MVIJ00056-01	1	SLW	IN60
	Motor Cut-off Switch Lever	OPERATING SPRING FOR MICRO SWITCH	MVIJ00027-01	1	SLW	IN60
	Charging Pawl with Bush	Release lever assembly	MVIJ00178-01	2	SLW	IN60
	Over Ride Stop	Over Ride Stop	MVIE00013-09	1	SLW	IN60
	Gasket for Over Ride Stop	Gasket for Over Ride Stop	MVIJ00063-01	1	SLW	IN60
	Operation Counter	Operation Counter	MVIJ00172-02	1	SLW	IN60

Item Identification	Variants	Discription	Part code	Qty Per VCB (no)	Plant Name	Plant code
	TRIP COIL BOX ASSY WITH SINGLE PLUNGER W/O COIL	TRIP COIL BOX ASSY WITH SINGLE PLUNGER W/O COIL	SPR39SASS0007FN_S	1	SLW	IN60
	RELEASE COIL ASSLY WITH PLUNGER W/O COIL	RELEASE COIL ASSLY WITH PLUNGER W/O COIL	SPR39SASS0008FN_S	1	SLW	IN60
Operating coils						
	Trip coil - 24 V DC - CN 1338	Trip coil - 24 V DC - CN 1338	ECO39SN133800FN	1	SLW	IN60
	Trip coil - 30 V DC - CN 1339	Trip coil - 30 V DC - CN 1339	ECO39SN133900FN	1	SLW	IN60
	Trip coil - 50 V DC - CN 1340	Trip coil - 50 V DC - CN 1340	ECO39SN134000FN	1	SLW	IN60
	Trip coil - 110 V DC - CN 1341	Trip coil - 110 V DC - CN 1341	ECO39SN134100FN	1	SLW	IN60
	Trip coil - 220 V DC - CN 1343	Trip coil - 220 V DC - CN 1343	ECO39SN134300FN	1	SLW	IN60
	Closing coil - 24 V DC - CN 1346	Closing coil - 24 V DC - CN 1346	ECO39SN134600FN	1	SLW	IN60
	Closing coil - 30 V DC - CN 1347	Closing coil - 30 V DC - CN 1347	ECO39SN134700FN	1	SLW	IN60
	Closing coil - 50 V DC - CN 1348	Closing coil - 50 V DC - CN 1348	ECO39SN134800FN	1	SLW	IN60
	Closing coil - 110 V DC - CN 1349	Closing coil - 110 V DC - CN 1349	ECO39SN134900FN	1	SLW	IN60
	Closing coil - 220 V DC - CN 1351	Closing coil - 220 V DC - CN 1351	ECO39SN135100FN	1	SLW	IN60
Auxiliary & Control Circuit						
	RECTIFIER 16A,1000P MONOBLOCK	RECTIFIER 16A,1000P MONOBLOCK	ERC-A-A00DC-001	1	SLW	IN60
	64 Pin Plug & Socket Assembly	64 Pin Plug & Socket Assembly	MHU39S00196200FN	1	SLW	IN60
	Interlock Assembly Components for Secondary Plug & Socket	Interlock Assembly Components for Secondary Plug & Socket	MKT39S0001000CM	1	SLW	IN60
Fabricated Trolley						
	Top Guide Roller	Ball Bearing No:6201	MBR39S4323100FN	1	SLW	IN60
	Breaker Wheel - Nylon	Wheel - Nylon	MVIA00054-01	4	SLW	IN60
	Breaker Wheel - Cast Iron	Cast Iron Wheel with bearing HK12X16	MVIK00025-01	4	SLW	IN60
Front Facia						
	Shutter for Racking Shaft	Shutter for Racking Shaft	MVJ00016-01	1	SLW	IN60
	Interlock Handle (Dia - 6mm hex) <small>(Dia - 5mm hex is obsolete)for alternate please place order of Interlock handle + Operating handle (Dia- 6mm) + Guide bush together</small>	Interlock Handle	MVJ00028-01	1	SLW	IN60
	Operating Handle for (Dia - 6mm hex)	HANDLE FOR MANUAL LOCK/FREE ASSY	MNM-39-A0238301	1	SLW	IN60
	Guide Bush	Guide Bush	AGSC72964-01	1	SLW	IN60
	Push to Trip Knob (RED) Assembly	Push to Trip Knob (RED) Assembly	SPR39SASS0001FN_S	1	SLW	IN60
	Push to Close Knob (GREEN) Assembly	Push to Close Knob (GREEN) Assembly	SPR39SASS0002FN_S	1	SLW	IN60

Item Identification	Variants	Discription	Part code	Qty Per VCB (no)	Plant Name	Plant code
	On - Off Indicator Assembly - With Spring	On - Off Indicator Assembly	SPR39SASS0003FN	1	SLW	IN60
	Charge -Free Indicator Assembly-With Spring	Charge -Free Indicator Assembly-With Spring	SPR39SASS0004FN	1	SLW	IN60

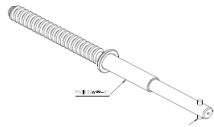
Racking Screw

	Long Racking screw 30 dia-660W	Long Racking screw 30 dia-660W	MVIK00367-02	1	SLW	IN60
	Long Racking screw 30 dia-860W	Long Racking screw 30 dia-860W	MVIK00367-03	1	SLW	IN60

BUSBAR & CT CHAMBER ARRANGEMENT (MENTION PANEL SERIAL NO.)

	1-Phase Busbar Spout for 800/1250A Panel - R/B Phase	1-Phase Busbar Spout for 800/1250A Panel - R/B Phase	MEP-39-A0227001	2	SLW	IN60
	1-Phase Busbar Spout for 800/1250A Panel - Y Phase	1-Phase Busbar Spout for 800/1250A Panel - Y Phase	MEP-39-A0227101	1	SLW	IN60
	1-Phase Busbar Spout for 1600A Panel - R/B Phase	1-Phase Busbar Spout for 1600A Panel - R/B Phase	MEP-39-A0227002	2	SLW	IN60
	1-Phase Busbar Spout for 1600A Panel - Y Phase	1-Phase Busbar Spout for 1600A Panel - Y Phase	MEP-39-A0227102	1	SLW	IN60
	1-Phase Busbar Spout for 2000A Panel - R/B Phase	1-Phase Busbar Spout for 2000A Panel - R/B Phase	MEP-39-A0229501	2	SLW	IN60
	1-Phase Busbar Spout for 2000A Panel - Y Phase	1-Phase Busbar Spout for 2000A Panel - Y Phase	MEP-39-A0229801	1	SLW	IN60
	1-Phase Busbar Spout for 2500/3150A Panel - R/B Phase	1-Phase Busbar Spout for 2500/3150A Panel - R/B Phase	MEP-39-A0229502	2	SLW	IN60
	1-Phase Busbar Spout for 2500/3150A Panel - Y Phase	1-Phase Busbar Spout for 2500/3150A Panel - Y Phase	MEP-39-A0229802	1	SLW	IN60
	1-Phase Busbar/Circuit Spout for 4000A Panel - R/Y/B Phase without Contact	1-Phase Busbar/Circuit Spout for 4000A Panel - R/Y/B Phase without Contact	MEP-39-A0230801	6	SLW	IN60
	Contact element assembly for 4000A/5000A	Contact element assembly for 4000A/5000A	MSC-39-A0228701	6	SLW	IN60
	1-Phase Circuit Spout for 1600A/2000A Panel - R/Y/B Phase	1-Phase Circuit Spout for 1600A/2000A Panel - R/Y/B Phase	MEP-39-A0164301	3	SLW	IN60
	1-Phase Circuit Spout for 800A/1250A Panel - R/Y/B Phase	1-Phase Circuit Spout for 800A/1250A Panel - R/Y/B Phase	MEP-39-A0227201	3	SLW	IN60
	1-Phase Circuit Spout for 1600A Panel - R/Y/B Phase	1-Phase Circuit Spout for 1600A Panel - R/Y/B Phase	MEP-39-A0227202	3	SLW	IN60
	1-Phase Circuit Spout for 2500/3150A Panel - R/Y/B Phase	1-Phase Circuit Spout for 2500/3150A Panel - R/Y/B Phase	MEP-39-A0229901	3	SLW	IN60

Earthing Arrangement

	Earthing Socket	Earthing Socket	MVIK00139-01	1	SLW	IN60
---	-----------------	-----------------	--------------	---	-----	------

	Earthing Nut	Earthing Nut	MVIK00023-01	1	SLW	IN60
	Shutter Assembly For Busbar/ Circuit Spout - 660 (Alu-Zn sheet)	Shutter Assembly For Busbar/ Circuit Spout - 660 (Alu-Zn sheet)	SPP0009-06	1	SLW	IN60
	Shutter Assembly For Busbar/ Circuit Spout - 860 (Alu-Zn sheet)	Shutter Assembly For Busbar/ Circuit Spout - 860 (Alu-Zn sheet)	SPP0009-07	1	SLW	IN60
	Shutter Assembly For Busbar/ Circuit Spout -860 - 4000A(Alu-Zn sheet)	Shutter Assembly For Busbar/ Circuit Spout - 860 - 4000A(Alu-Zn sheet)	SPP0009-08	1	SLW	IN60

POTENTIAL TRANSFORMER (FUSE)

	HRC Fuse-PT HT Side VTF-11, 3A	HRC Fuse-PT HT Side VTF-11, 3A	EHF-A-EV000-001	3	SLW	IN60
	HRC Fuse-PT HT Side VTF 6.6, 3A	HRC Fuse-PT HT Side VTF 6.6, 3A	EHF-B-BBA00-001	2	SLW	IN60

OTHER

	Limit Switch-1NO+1NC - Service/Test Position	Limit Switch-1NO+1NC - Service/Test Position	ESW-B-AAA00-001	8	SLW	IN60
	RECTIFIER 16A,1000P MONOBLOCK	RECTIFIER 16A,1000P MONOBLOCK	ERC-A-A00DC-001	1	SLW	IN60
	Busbar Support Insulator - 40KA	Busbar Support Insulator - 40KA	MEP-39-A0147901	x	SLW	IN60
	Busbar Support Insulator - 25KA	Busbar Support Insulator - 25KA	MEP-27-30370B	x	SLW	IN60
	Thermostat For Space Heater	Thermostat For Space Heater	ETH-E-B0000-001	1	SLW	IN60
	Space Heater	Space Heater	EHT-A-AA000-001	1	SLW	IN60

HWC

Item Identification	Variants	Discription	Part code	Qty Per VCB	Plant Name	Plant code
VACUUM CONTACTOR UNIT						
	Magnet Core	Magnet Core	MST37S4010100PL	2	SLW	IN60
	Magnet Core Shim	Magnet Core Shim	MBC37S4011900BL	2	SLW	IN60
	Push On Spring	Push On Spring	MSP37S4010400PL	2	SLW	IN60
	Spring Seat	Spring Seat	MST37S4011600PL	2	SLW	IN60
	Spring Support Post	Spring Support Post	MST37S4015700PL	2	SLW	IN60
	Spring Adjuster	Spring Adjuster	MST37S4015800PL	2	SLW	IN60

Item Identification	Variants	Discription	Part code	Qty Per VCB (no)	Plant Name	Plant code
	Special Lock Nut	Special Lock Nut	MST37S4015900PL	2	SLW	IN60
	Coil "O" Ring	Coil "O" Ring	MPL37S4011500FN	2	SLW	IN60
	Coil Washer	Coil Washer	MSH37S4011300PL	2	SLW	IN60
	Location Disc -Upper	Location Disc -Upper	MPL37S4016400FN	3	SLW	IN60
	Location Disc -Lower	Location Disc -Lower	MPL37S4016500FN	3	SLW	IN60
	Hinge Unibal	Hinge Unibal	MBR37S4016300FN	3	SLW	IN60
	Unibal Clamp Plate	Unibal Clamp Plate	MSH37S4011100PL	6	SLW	IN60
	Hinge Unibal Bearing	Hinge Unibal Bearing	MST37S4016200FN	2	SLW	IN60
	Stop Screw Assembly	Stop Screw Assembly	MST37S4011000PL	1	SLW	IN60
	Amature Stop Pad	Amature Stop Pad	MPL37S4011200FN	1	SLW	IN60
	Armature Moulding	Armature Moulding	MSM37S1000300FN	1	SLW	IN60
	Insert	Insert	MBC37S4041900MC	2	SLW	IN60
	Tapped Plate	Tapped Plate	MST37S4016000PL	2	SLW	IN60
	Terminal Board Moulding	Terminal Board Moulding	MSM37S2000100FN	1	SLW	IN60
	Mounting Tray	Mounting Tray	MSH37S3010100PL	1	SLW	IN60
	Main Frame Moulding	Main Frame Moulding	MSM37S1000200FN	1	SLW	IN60
	Armature Plate	Armature Plate	MST37S3010300PL	1	SLW	IN60
	TQ Auxiliary Switch L/H-4NO + 4NC	TQ Auxiliary Switch L/H-4NO + 4NC	MOC37S2000200FN	1	SLW	IN60
	TQ Auxiliary Switch R/H-4NO + 4NC	TQ Auxiliary Switch R/H-4NO + 4NC	MOC37S2000300FN	1	SLW	IN60
	TQ Auxiliary Switch L/H-6NO + 6NC	TQ Auxiliary Switch L/H-6NO + 6NC	SLWI00090-04	1	SLW	IN60
	TQ Auxiliary Switch R/H-6NO + 6NC	TQ Auxiliary Switch R/H-6NO + 6NC	SLWI00090-03	1	SLW	IN60
	Auxiliary Switch 5NO + 5NC (Imported)	Auxiliary Switch Single 5NO + 5NC	DRCN01726-01	1	SLW	IN60
	Operating Coil 110 V DC	Operating Coil 110V-220V DC (Imported)	DRC001966-04	2	SLW	IN60
	Operating Coil 24-35V DC	Operating Coil 24-60V DC (Imported)	DRC001966-01	2	SLW	IN60
	GP6 Resistor Type GP6/30 -110V DC	GP6 Resistor Type GP6/30 -110V DC	ECU37S4040200FN	1	SLW	IN60
	GP6 Resistor Type GP6/35 -220V DC	GP6 Resistor Type GP6/35 -220V DC	ECU37S4046600FN	1	SLW	IN60
	GP6 Resistor Type GP6/15 -24-35V DC	GP6 Resistor Type GP6/15 -24-35V DC	ECU37SGP6-1500FN	1	SLW	IN60
	Latch-In-Mechanism with 220V DC coil	Latch-In-Mechanism W/O Tripping Coil	DRCN01586-01	1	SLW	IN60
	Latch-In-Mechanism Coil 110V DC	Latch-In-Mechanism Tripping Coil 110V-220V DC (Imported)	DRC001749-01	1	SLW	IN60
	Latch-In-Mechanism Coil 24-35V DC	Latch-In-Mechanism Tripping Coil 24V-60V DC (Imported)	DRC001749-03	1	SLW	IN60
	Vacuum Interrupter Type C6B Assembly With Stud, Flex & Contact Block	Vacuum Interrupter Type C6B Assembly With Stud, Flex & Contact Block	SPR37SASS0000FN_S	1	SLW	IN60
	Flex Connection 400A	Flex Connection 400A	MCU37S0105M00PL	3	SLW	IN60
	Adaptor Block	Adaptor Block	MCU37S0106M00PL	3	SLW	IN60
	Connection Block -Lower	Connection Block -Lower	MCU37S0153M00PL	3	SLW	IN60
	HT Brass Stud	HT Brass Stud	MBC37S4075200MC	3	SLW	IN60
	Rear Connection	Rear Connection	MCU37S4010200PL	9	SLW	IN60
KIT AND CARRIAGE ASSEMBLY						
	Isolating Contact -800A -Finger Type	Isolating Contact -800A -Finger Type	MHU39S0523600FN	6	SLW	IN60
	Isolating Contact -800A -Flat Type	Isolating Contact -800A -Flat Type	MVIK00190-01	9	SLW	IN60
	Lower Terminal Moulding (Suitable For 1 Pair Finger Contact)**	Lower Terminal Moulding (Suitable For 1 Pair Finger Contact)**	SLWD00029-01	1	SLW	IN60
	Fuse Trip Mechanism Assembly (W/o Limit Switch) for HWX-Old	Fuse Trip Mechanism Assembly (W/o Limit Switch) for HWX-Old	MVU25S3550800SA	1	SLW	IN60
	Fuse Trip Mechanism Assembly (W/o Limit Switch) for HWX-S	Fuse Trip Mechanism Assembly (W/o Limit Switch) for HWX-S	MVIK00671-01	1	SLW	IN60
	Top Guide Roller	Top Guide Roller	MVIB00455-01	1	SLW	IN60
	Breaker Wheel - Nylon	Breaker Wheel - Nylon	MVIA00054-01	4	SLW	IN60
	Shutter for Racking Shaft with Tripping link (with latch) for HWC-S	Shutter for Racking Shaft with Tripping link (with latch) for HWC-S	MVIK00663-01	1	SLW	IN60
	Shutter for Racking Shaft with Tripping link (with latch) for HWC-C	Shutter for Racking Shaft with Tripping link (with latch) for HWC-C	MVIK00272-01	1	SLW	IN60
	Interlock Handle	Interlock Handle	MVJ00028-01	1	SLW	IN60
	Push to Trip Knob (RED) Assembly- With Spring & Housing	Push to Trip Knob (RED) Assembly- With Spring & Housing	SPR39SASS0001FN_S	1	SLW	IN60
	On -Off Indicator	On -Off Indicator	MVIK00293-01	1	SLW	IN60
SECONDARY PLUG & SOCKET COMPONENTS						
	32 Pin Plug & Socket Assembly	32 Pin Plug & Socket Assembly	MHU39S0042400FN	1	SLW	IN60
	64 Pin Plug & Socket Assembly	64 Pin Plug & Socket Assembly	MHU39S00196200FN	1	SLW	IN60
	Interlock Assembly Components for Secondary Plug & Socket	Interlock Assembly Components for Secondary Plug & Socket	MKT39S0001000CM	1	SLW	IN60

Item Identification	Variants	Description	Part code	Qty Per VCB (no)	Plant Name	Plant code
HT CHAMBER ARRANGEMENT (MENTION PANEL SERIAL NO.)						
	3 Phase Bus Bar Spout for HWC-Old	3 Phase Bus Bar Spout for HWC-Old	MEP-39-38627	1	SLW	IN60
	1 Phase Circuit Spout for HWC-Old	1 Phase Circuit Spout for HWC-Old	MEP-25-35555	3	SLW	IN60
	1-Phase Busbar Spout for R/B Phase-HWC-S	1-Phase Busbar Spout for R/B Phase-HWC-S	MEP-39-A0227001	2	SLW	IN60
	1-Phase Busbar Spout - Y Phase-HWC-S	1-Phase Busbar Spout - Y Phase-HWC-S	MEP-39-A0227101	1	SLW	IN60
	1-Phase Circuit Spout R/Y/B Phase - HWC-S	1-Phase Circuit Spout R/Y/B Phase - HWC-S	MEP-39-A0227201	3	SLW	IN60
	Busbar Support Insulator - 40KA	Busbar Support Insulator - 40KA	MEP-39-A0147901	x	SLW	IN60
	Busbar Support Insulator - 25KA	Busbar Support Insulator - 25KA	MEP-27-30370B	x	SLW	IN60

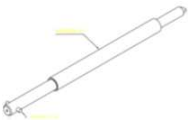
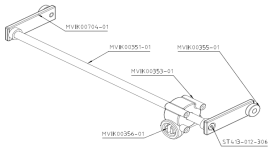
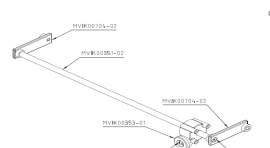
RACKING, SHUTTER AND EARTHING ARRANGEMENT*						
	Racking Screw for HWC-Old	Racking Screw for HWC-Old	MVIK00064-01	1	SLW	IN60
	Racking Screw for HWC-S	Racking Screw for HWC-S	MVIK00367-02	1	SLW	IN60
	RACKING ARRANGEMENT ASSLY FOR HWX-C(660W)	RACKING ARRANGEMENT ASSLY FOR (660W)	MVIK00296-01	1	SLW	IN60
	RACKING ARRANGEMENT ASSLY FOR HWX-C(860W)	RACKING ARRANGEMENT ASSLY FOR (860W)	MVIK00296-02	1	SLW	IN60
	Racking Nut - 20MM DIA	Racking Nut - 20MM DIA	MBC-39-32417	1	SLW	IN60
	Racking Nut - 30 dia	Racking Nut - 30 dia	MNM-39-A0115701	1	SLW	IN60
	Earthing Socket	Earthing Socket	MVIK00139-01	1	SLW	IN60
	Earthing Nut	Earthing Nut	MVIK00023-01	1	SLW	IN60
	Electronic Card 24V-60V DC (Imported)	Electronic Card 24V-60V DC (Imported)	DRC003817-01	1	SLW	IN60
	Electronic Card 110V-220V DC (Imported)	Electronic Card 110V-220V DC (Imported)	DRC003817-02	1	SLW	IN60
	Wiring Harness for CBX for PIX-ROF Application	Wiring Harness for CBX for PIX-ROF Application	VDRK00258-01	1	SLW	IN60
	Wiring Harness for CBX for HWC Application	Wiring Harness for CBX for HWC Application	VDRK00258-02	1	SLW	IN60
OTHER						
	Limit Switch-1NO+1NC - Service/Test Position	Limit Switch-1NO+1NC - Service/Test Position	ESW-B-AAA00-001	8	SLW	IN60
	Rectifier Monoblock	Rectifier Monoblock	ERC-A-A00CC-001	x	SLW	IN60
	Thermostat For Space Heater	Thermostat For Space Heater	ETH-E-B0000-001	x	SLW	IN60
	Space Heater	Space Heater	EHT-A-AA000-001	1	SLW	IN60







VMX - 606

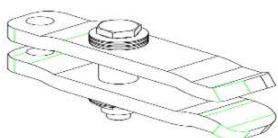

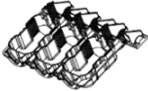
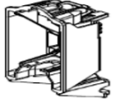
Item Identification	Variants	Description	Part code	Qty Per VCB	Plant Name	Plant code
BREAKER KIT ASSEMBLY - 630/800/1200A						
	Epoxy Body	Epoxy Body	MEP27S2046100FN	1	Ecofit	IN66
	Modified Pin	Modified Pin	MST27S0393803PL	1	Ecofit	IN66
	Spider	Spider	MCS27S0714701PN	1	Ecofit	IN66
	Opening Buffer	Opening Buffer	SJMPL27S0435701FN	1	Ecofit	IN66
	Grommet	Grommet	MPL27S0396701FN	3	Ecofit	IN66
	Y-Phase Shroud	Y-Phase Shroud	MPI27S4166500FN	1	Ecofit	IN66
	Neber Washer	Neber Washer	MPL27S0052818FN	3	Ecofit	IN66
	Drive Beam Pair	Drive Beam Pair	MCS27S0298700PN	1	Ecofit	IN66
	Dust-Proof Cover	Dust-Proof Cover	MPL27S4019400FN	6	Ecofit	IN66
	Drive Rod	Drive Rod	SJMST27S0389700PL	1	Ecofit	IN66
	Drive Insulator Assembly with M10 Nyloc Nut & Spl.Washer	Drive Insulator Assembly with M10 Nyloc Nut & Spl.Washer	SJMEP27S001191AFN	3	Ecofit	IN66
VACUUM INTERRUPTER ASSEMBLY WITH FIXED CONTACT						
	VG 2RG	VG 2RG	MVU27S0VG2R00FN	3	Ecofit	IN66
VACUUM INTERRUPTER ASSEMBLY WITH FLEX CONNECTION						
	VG 2RG - R Phase	VG 2RG - R Phase	MVU27SVG2RG0RSA	1	Ecofit	IN66
	VG 2RG - Y Phase	VG 2RG - Y Phase	MVU27SVG2RG0YSA	1	Ecofit	IN66
	VG 2RG - B Phase	VG 2RG - B Phase	MVU27SVG2RG0BSA	1	Ecofit	IN66
630/800A BREAKER KIT ASSEMBLY						
	Breaker Bushing	Breaker Bushing	MEP27S3070400FN	3	Ecofit	IN66
	Socket Contact	Socket Contact	MCU27S3398201FN	6	Ecofit	IN66
	Half Collar (Pair)	Half Collar (Pair)	SJMCB27S0396901MC	3	Ecofit	IN66
	Brass Nut	Brass Nut	MBC27S0394102MC	3	Ecofit	IN66
	Top Clamps with Hardwar (Pair) - R/B Phase	Top Clamps with Hardwar (Pair) - R/B Phase	SJMCB27S0295700UP	2	Ecofit	IN66
	Top Clamps with Hardware (Pair) - Y Phase	Top Clamps with Hardware (Pair) - Y Phase	MBC27S0360601UP	1	Ecofit	IN66
	Ring for Isolating Socket 630/800A	Ring for Isolating Socket 630/800A	MBC27S3398202MC	6	Ecofit	IN66
1250A BREAKER KIT ASSEMBLY						
	Breaker Bushing	Breaker Bushing	MEP27S0011802FN	3	Ecofit	IN66

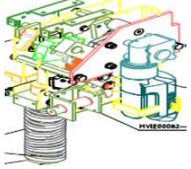
Item Identification	Variants	Discription	Part code	Qty Per VCB (no)	Plant Name	Plant code
Conductor Between VI & Socket - 1250A (Suitable For V207G & VG2)	Socket Contact	Socket Contact	SJMCU4X734800PL	6	Ecofit	IN66
	- R/B Phase	- R/B Phase	MCU27S3127102PL	2	Ecofit	IN66
	-Y Phase	-Y Phase	MCU27S3127101PL	1	Ecofit	IN66
	Half Collar (Pair)	Half Collar (Pair)	MBC27S0394201MC	3	Ecofit	IN66
	Brass Nut	Brass Nut	MBC27S0394101MC	3	Ecofit	IN66
	Top Clamps with Hardware (Pair) - R/B Phase	Top Clamps with Hardware (Pair) - R/B Phase	SJMCU27S0295601PL	2	Ecofit	IN66
	Top Clamps with Hardware (Pair) - Y Phase	Top Clamps with Hardware (Pair) - Y Phase	SJMCU27S0360602PL	1	Ecofit	IN66
	Ring for Isolating Socket	Ring for Isolating Socket	MBC27S073483MC	6	Ecofit	IN66
BREAKER COVERS						
	Top Cover	Top Cover	MPL27S0775901FN	1	Ecofit	IN66
	Middle Cover	Middle Cover	MPL27S1174601FN	1	Ecofit	IN66
	Bottom Cover	Bottom Cover	MPL27S0714301FN	1	Ecofit	IN66
	Clip	Clip	MPL27S0046800FN	2	Ecofit	IN66
MOTOR-CHARGE SPRING MECHANISM TYPE SPMX-500 FORM-AM						
	Ratchet Wheel Assembly	Ratchet Wheel Assembly	MVIE00151-01_S	1	Ecofit	IN66
	Charging Pawl Set	Charging Pawl Set	MST27SSD28500BL (MVIE00109-01) & MST27SSD28400BL (MVIE00106-01)	1	Ecofit	IN66
	Handle Block Assembly	Handle Block Assembly	MVU27S0004900CM	1	Ecofit	IN66
	Eccentric Drive	Eccentric Drive	MST27SD214100PL	1	Ecofit	IN66
	Release Prop	Release Prop	MST27S0310600BL	1	Ecofit	IN66
	Pin for Release Prop	Pin for Release Prop	MST27SD209000NA	1	Ecofit	IN66
	Bearing	Bearing	MBR27SNAST800NA	1	Ecofit	IN66
	Pin for Bearing	Pin for Bearing	MST27SSD12500NA	1	Ecofit	IN66
	Release/Closing Coil					
	24VDC - CN 1176	24VDC - CN 1176	ECO27SN117600FN	1	Ecofit	IN66
	30VDC - CN1177	30VDC - CN1177	ECO27SN117700FN	1	Ecofit	IN66
	48VDC - CN1178	48VDC - CN1178	ECO27SN117800FN	1	Ecofit	IN66
	110VDC - CN1179	110VDC - CN1179	ECO27SN117900FN	1	Ecofit	IN66
	220VDC - CN1180	220VDC - CN1180	ECO27SN118000FN	1	Ecofit	IN66
	220VAC - CN1325	220VAC - CN1325	ECO27SN132500FN	1	Ecofit	IN66
	Shunt Trip Coil					
	24VDC - OG 835	24VDC - OG 835	MVIE00242-01	1	Ecofit	IN66
	30VDC - OG 836	30VDC - OG 836	ECO27SOG83600FN	1	Ecofit	IN66
	48VDC - OG 837	48VDC - OG 837	ECO27SOG83700FN	1	Ecofit	IN66
	110VDC - OG 838	110VDC - OG 838	ECO27SOG83800FN	1	Ecofit	IN66
	220VDC - OG 839	220VDC - OG 839	ECO27SOG83900FN	1	Ecofit	IN66
	220VAC - OG 870	220VAC - OG 870	ECO27SOG87000FN	1	Ecofit	IN66
	Release Coil Box Assembly with Plunger -without Coil	Release Coil Box Assembly with Plunger - without Coil	MVIE00082-01	1	Ecofit	IN66
	Trip Coil Box Assembly with Plunger - without Coil	Trip Coil Box Assembly with Plunger - without Coil	MVIE00231-01	1	Ecofit	IN66
	Trip Prop Block Assembly	Trip Prop Block Assembly	MVIE0023-01	1	Ecofit	IN66
	Auxiliary Switch - 12 Way Box Type	Auxiliary Switch - 12 Way Box Type	SJMVU27S3140000FN	1	Ecofit	IN66
	Drive Link for Auxiliary Switch	Drive Link for Auxiliary Switch	MST27S3265700PL	1	Ecofit	IN66
	Auxiliary Switch Drive Lever Assembly	Auxiliary Switch Drive Lever Assembly	MVU27S0004200CM	1	Ecofit	IN66
	Motor Cut-Off Switch	Motor Cut-Off Switch	SJSPREU27S03076FN	1	Ecofit	IN66
	Push Rod	Push Rod	MBC27SD201200NA	1	Ecofit	IN66
	Closing Buffer for Spring	Closing Buffer for Spring	MVIE00060-01	1	Ecofit	IN66
	Dashpot Assembly	Dashpot Assembly	SJMVU27S3828900FN	1	Ecofit	IN66
	Override Stop with Gasket	Override Stop with Gasket	MVIE00013-09	1	Ecofit	IN66
	Override Stop Pin	Override Stop Pin	MVIE00232-01	1	Ecofit	IN66
	Operation Counter	Operation Counter	MVIE00130-01	1	Ecofit	IN66
	Packer (1No.)	Packer (1No.)	SJMSH27S0309600PL	8	Ecofit	IN66
SECONDARY PLUG & SOCKET COMPONENTS						
	Secondary Plug Board Assembly - 28Way	Secondary Plug Board Assembly - 28Way	MVU27S3139900FN	1	Ecofit	IN66
	Secondary Socket Board Assembly - 28Way	Secondary Socket Board Assembly - 28Way	SJMVU27S3139900FM	1	Ecofit	IN66
PT Fuse						
	HRC Fuse-PT HT Side VTF-11, 3A	HRC Fuse-PT HT Side VTF-11, 3A	EHF-A-EV000-001	3	Ecofit	IN66
	HRC Fuse-PT HT Side VTF 6.6, 3A	HRC Fuse-PT HT Side VTF 6.6, 3A	EHF-B-BBA00-001	3	Ecofit	IN66
OPERATING TOOLS AND GAUGES						
	Raising & Lowering Handle	Raising & Lowering Handle	MVM-27-355291	1	Ecofit	IN66
	Emergency Charging Handle for Motor Mechanism	Emergency Charging Handle for Motor Mechanism	MVM-27-428931	1	Ecofit	IN66
OTHER						
	Limit Switch-1NO+1NC - Service/Test Position	Limit Switch-1NO+1NC - Service/Test Position	ESW-B-AAA00-001	8	Ecofit	IN66
	Rectifier Monoblock (Mention Specifications)	Rectifier Monoblock (Mention Specifications)	ERC-A-A00CC-001	1	Ecofit	IN66
	Busbar Support Insulator	Busbar Support Insulator	MEP-27-30370B	x	Ecofit	IN66
	Thermostat for Space Heater	Thermostat for Space Heater	ETH-E-B0000-001	1	Ecofit	IN66
	Space Heater	Space Heater	EHT-A-AA000-001	1	Ecofit	IN66

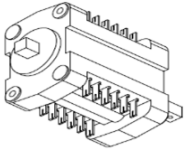
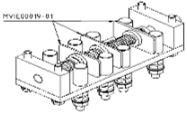
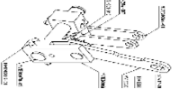
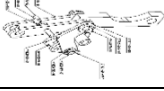
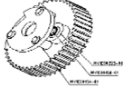

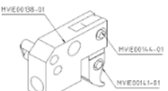
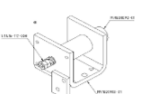
PIX - MV

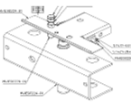
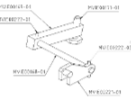
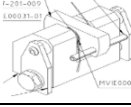
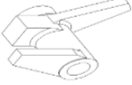
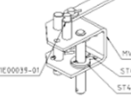
Item Identification	Variants	Discription	Part code	Qty Per VCB	Plant Name	Plant code
ISOLATING CONTACT - FLAT TYPE						
	800/1250A	ISOLATING CONTACT FLAT TYPE 630A-1250A	MVIG00134-01	12	SLW	IN60
	1600A-2000A	ISOLATING CONTACT FLAT TYPE 1600A-2000A	MVIG00134-02	24	SLW	IN60

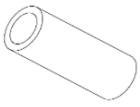
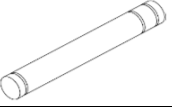
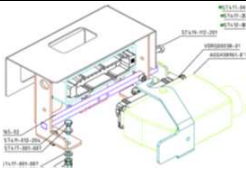
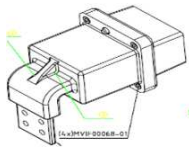
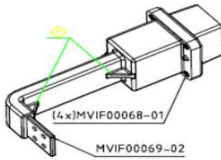
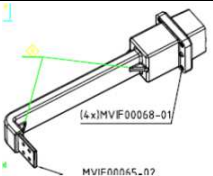
Item Identification	Variants	Discription	Part code	Qty Per VCB (no)	Plant Name	Plant code
VACUMM INTERRUPTER						
	VG2	VACUMM INTERRUPTER VG2	DRCVG2002-01	3	SLW	IN60
	VG3	VACUMM INTERRUPTER VG3	VSLVG3002-01	3	SLW	IN60
BREAKER HOUSING						
	HVX-LR	BREAKER HOUSING HVX-LR	DRC006260-01	1	SLW	IN60
	HVX-HR	BREAKER HOUSING HVX-LR	DRC006259-01	3	VDR	IN58
	Insulating Rod	ISULATING ROD	DRCN03177-01	3	SLW	IN60
VCB OPERATING MECHANISM						
	VCB Operating Mechanism W/O coil & Motor	VCB Operating Mechanism W/O coil & Motor	VDRE00001-05-LR	1	SLW	IN60
Closing Coil						
	24VDC - CN 1176	CLOSING COIL 24VDC	ECO27SN117600FN	1	SLW	IN60
	30VDC - CN1177	CLOSING COIL 30VDC	ECO27SN117700FN	1	SLW	IN60
	48VDC - CN1178	CLOSING COIL 48VDC	ECO27SN117800FN	1	SLW	IN60
	110VDC - CN1179	CLOSING COIL 110VDC	ECO27SN117900FN	1	SLW	IN60
	220VDC - CN1180	CLOSING COIL 220VDC	ECO27SN118000FN	1	SLW	IN60
Tripping Coil						
	24VDC - OG 835	TRIPPING COIL 24VDC	MVIE00242-01	1	SLW	IN60
	30VDC - OG 836	TRIPPING COIL 30VDC	ECO27SOG83600FN	1	SLW	IN60
	48VDC - OG 837	TRIPPING COIL 48VDC	ECO27SOG83700FN	1	SLW	IN60
	110VDC - OG 838	TRIPPING COIL 110VDC	ECO27SOG83800FN	1	SLW	IN60
	220VDC - OG 839	TRIPPING COIL 220VDC	ECO27SOG83900FN	1	SLW	IN60
Spring Charging Motor						
	110V AC/DC	SPRING CHARGING MOTOR 110V AC/DC	VDRE00100-01	1	SLW	IN60
	200V- 250V AC/DC	SPRING CHARGING MOTOR 200V - 250V AC/DC	VDRE00100-02	1	SLW	IN60
Breaker Auxiliary Switch						
	6NO + 6NC	BREAKER AUXILIARY SWITCH (6NO + 6NC)	MVIG00242-01	1	SLW	IN60
Other Mechanism Components						
	Motor Cut-off Switch	Motor Cut-off Switch	MVIE00016-01	1	SLW	IN60
	Main Drive Shaft Assembly	Main Drive Shaft Assembly	MVIE00062-01	1	SLW	IN60
	Trip Fork Linkage Assembly	Trip Fork Linkage Assembly	MVIE00072-01	1	SLW	IN60
	Ratchet Wheel	Ratchet Wheel	MVIE00151-01_S	1	SLW	IN60
	Pin For Ratchet.	Pin For Ratchet.	MVIE00079-01	1	SLW	IN60
	Handle Block Assembly	Handle Block Assembly	MVIE00137-01	1	SLW	IN60
	Closing Coil Box Assembly (Without coil)	Closing Coil Box Assembly (Without coil)	MVIE00082-01	1	SLW	IN60

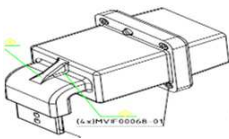
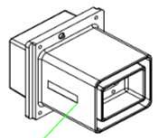
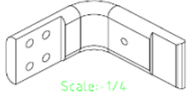
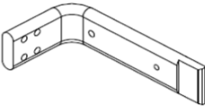
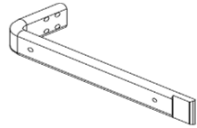
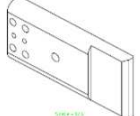
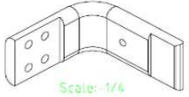
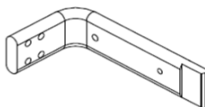
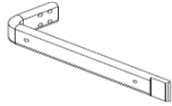
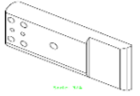
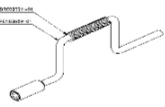
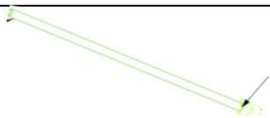
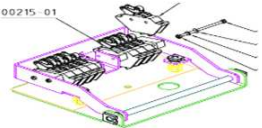
Item Identification	Variants	Discription	Part code	Qty Per VCB (no)	Plant Name	Plant code
	Trip Coil Box Assembly (Without Coil)	Trip Coil Box Assembly (Without Coil)	MVIE00231-01	1	SLW	IN60
	Motor Cut Off Lever Assy	Motor Cut Off Lever Assy	MVIE00173-01	1	SLW	IN60
	Trip Prop Support Assembly	Trip Prop Support Assembly	MVIE00023-01	1	SLW	IN60
	Release Lever	Release Lever	MVIE00123-02	1	SLW	IN60
	Pin For Release Lever	Pin For Release Lever	MVIE00136-01	1	SLW	IN60
	Auxiliary Switch Drive Assembly	Auxiliary Switch Drive Assembly	MVIE00034-01	1	SLW	IN60
	Charging Pawl	Charging Pawl	MVIE00106-01	1	SLW	IN60
	Charging Pawl	Charging Pawl	MVIE00109-01	1	SLW	IN60
	Buffer For Spring	Buffer For Spring	MVIE00060-01	1	SLW	IN60
	Over Ride Stop	Over Ride Stop	MVIE00013-09	1	SLW	IN60
	Over Ride Stop Pin	Over Ride Stop Pin	MVIE00232-01	1	SLW	IN60
SECONDARY PLUG & SOCKET COMPONENTS						
	24 Pin Plug & Socket Assembly	24 Pin Plug & Socket Assembly	MHU39S0019000FN		SLW	IN60
BUSBAR AND CABLE CHAMBER ARRANGEMENT (MENTION PANEL SERIAL NO.)						
	800A, R Phase Busbar Spout	800A, R Phase Busbar Spout	MVIF00072-02	1	SLW	IN60
	800A, Y Phase Busbar Spout	800A, Y Phase Busbar Spout	MVIF00070-02	1	SLW	IN60
	800A, B Phase Busbar Spout	800A, B Phase Busbar Spout	MVIF00066-02	1	SLW	IN60

Item Identification	Variants	Discription	Part code	Qty Per VCB (no)	Plant Name	Plant code
	800A, Circuit Spout	800A, Circuit Spout	MVIF00073-02	3	SLW	IN60
	1250A, R Phase Busbar Spout	1250A, R Phase Busbar Spout	MVIF00072-01	1	SLW	IN60
	1250A, Y Phase Busbar Spout	1250A, Y Phase Busbar Spout	MVIF00070-01	1	SLW	IN60
	1250A, B Phase Busbar Spout	1250A, B Phase Busbar Spout	MVIF00066-01	1	SLW	IN60
	1250A, Circuit Spout	1250A, Circuit Spout	MVIF00073-01	3	SLW	IN60
	2000A, R,Y,B Phase Busbar Spout /Circuit Spout	2000A, R,Y,B Phase Busbar Spout /Circuit Spout	VDRF00100-01	6	SLW	IN60
	2000A, R Phase Busbar Spout Connection - Cassete Type Panel	2000A, R Phase Busbar Spout Connection - Cassete Type Panel	VDRF00182-01	1	SLW	IN60
	2000A, Y Phase Busbar Spout Connection - Cassete Type Panel	2000A, Y Phase Busbar Spout Connection - Cassete Type Panel	VDRF00181-01	1	SLW	IN60
	2000A, B Phase Busbar Spout Connection - Cassete Type Panel	2000A, B Phase Busbar Spout Connection - Cassete Type Panel	VDRF00180-01	1	SLW	IN60
	2000A, Circuit Spout Connection - Cassete Type Panel	2000A, Circuit Spout Connection - Cassete Type Panel	VDRF00183-01	3	SLW	IN60
	2000A, R Phase Busbar Spout Connection - ROF Type Panel	2000A, R Phase Busbar Spout Connection - ROF Type Panel	VDRF00182-04	1	SLW	IN60
	2000A, Y Phase Busbar Spout Connection - ROF Type Panel	2000A, Y Phase Busbar Spout Connection - ROF Type Panel	VDRF00181-05	1	SLW	IN60
	2000A, B Phase Busbar Spout Connection - ROF Type Panel	2000A, B Phase Busbar Spout Connection - ROF Type Panel	VDRF00180-05	1	SLW	IN60
	2000A, Circuit Spout Connection - ROF Type Panel	2000A, Circuit Spout Connection - ROF Type Panel	VDRF00183-02	3	SLW	IN60
RACKING,SHUTTER AND EARTHING ARRANGEMENT						
	Rack -In /Rack -Out Handle - ROF Panel	Rack -In /Rack -Out Handle - ROF Panel	VDRG00157-01	1	SLW	IN60
	Rack -In /Rack -Out Handle - Cassete Type Panel	Rack -In /Rack -Out Handle - Cassete Type Panel	ST424-801-021	1	SLW	IN60
	Spring Charging Handle	Spring Charging Handle	MVIF00142-01	1	SLW	IN60
	Limit Switch Assembly	Limit Switch Assembly	MVIF00372-01	1	SLW	IN60

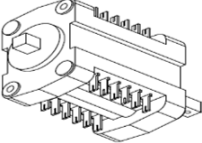
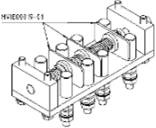
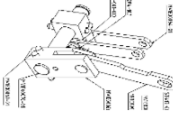
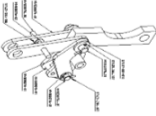
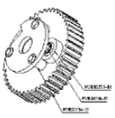
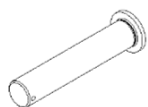
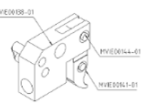
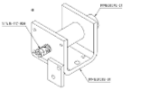
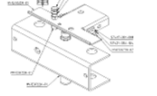
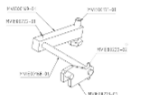
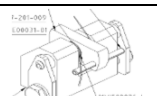
Item Identification	Variants	Discription	Part code	Qty Per VCB (no)	Plant Name	Plant code
Closing Coil						
	24VDC - CN 1176	CLOSING COIL 24VDC	ECO27SN117600FN	1	SLW	IN60
	30VDC - CN1177	CLOSING COIL 30VDC	ECO27SN117700FN	1	SLW	IN60
	48VDC - CN1178	CLOSING COIL 48VDC	ECO27SN117800FN	1	SLW	IN60
	110VDC - CN1179	CLOSING COIL 110VDC	ECO27SN117900FN	1	SLW	IN60
	220VDC - CN1180	CLOSING COIL 220VDC	ECO27SN118000FN	1	SLW	IN60
Tripping Coil						
	24VDC - OG 835	TRIPPING COIL 24VDC	MVIE00242-01	1	SLW	IN60
	30VDC - OG 836	TRIPPING COIL 30VDC	ECO27SOG83600FN	1	SLW	IN60
	48VDC - OG 837	TRIPPING COIL 48VDC	ECO27SOG83700FN	1	SLW	IN60
	110VDC - OG 838	TRIPPING COIL 110VDC	ECO27SOG83800FN	1	SLW	IN60
	220VDC - OG 839	TRIPPING COIL 220VDC	ECO27SOG83900FN	1	SLW	IN60
Spring Charging Motor						
	110V AC/DC	SPRING CHARGING MOTOR 110V AC/DC	VDRE00100-07	1	SLW	IN60
	125V AC/DC high speed	SPRING CHARGING MOTOR 125V AC/DC, high speed	VDRE00100-04	1	SLW	IN60
	220V AC/DC with Thermsiter	SPRING CHARGING MOTOR 220V AC/DC with thermister	VDRE00100-06	1	SLW	IN60
Breaker Auxiliary Switch						
	6NO + 6NC	BREAKER AUXILIARY SWITCH (6NO + 6NC)	MVIG00242-01	1	SLW	IN60
Other Mechanism Components						
	Motor Cut-off Switch	Motor Cut-off Switch	MVIE00016-01	1	SLW	IN60
	Main Drive Shaft Assembly	Main Drive Shaft Assembly	MVIE00062-01	1	SLW	IN60
	Trip Fork Linkage Assembly	Trip Fork Linkage Assembly	MVIE00072-01	1	SLW	IN60
	Ratchet Wheel	Ratchet Wheel	MVIE00151-01_S	1	SLW	IN60
	Pin For Ratchet.	Pin For Ratchet.	MVIE00079-01	1	SLW	IN60
	Handle Block Assembly	Handle Block Assembly	MVIE00137-01	1	SLW	IN60
	Closing Coil Box Assembly (Without coil)	Closing Coil Box Assembly (Without coil)	MVIE00082-01	1	SLW	IN60
	Trip Coil Box Assembly (Without Coil)	Trip Coil Box Assembly (Without Coil)	MVIE00231-01	1	SLW	IN60
	Motor Cut Off Lever Assy	Motor Cut Off Lever Assy	MVIE00173-01	1	SLW	IN60
	Trip Prop Support Assembly	Trip Prop Support Assembly	MVIE00023-01	1	SLW	IN60

Item Identification	Variants	Discription	Part code	Qty Per VCB (no)	Plant Name	Plant code
	Release Lever	Release Lever	MVIE00123-02	1	SLW	IN60
	Pin For Release Lever	Pin For Release Lever	MVIE00136-01	1	SLW	IN60
	Auxiliary Switch Drive Assembly	Auxiliary Switch Drive Assembly	MVIE00034-01	1	SLW	IN60
	Charging Pawl	Charging Pawl	MVIE00106-01	1	SLW	IN60
	Charging Pawl	Charging Pawl	MVIE00109-01	1	SLW	IN60
	Buffer For Spring	Buffer For Spring	MVIE00060-01	1	SLW	IN60
	Over Ride Stop	Over Ride Stop	MVIE00013-09	1	SLW	IN60
	Over Ride Stop Pin	Over Ride Stop Pin	MVIE00232-01	1	SLW	IN60
<p>Note :- PCOB -15 spares are obsolete, only pole assembly can be supported on case to case basis, based on site details. PCOB -36 :- Any manufacturing date on or before 2012, no spares are supported as its obsolete</p>						
*VCU has been replaced by CBX						

PIX-36

MV Switchgear Spares

Evolution of PIX-36 Cubicle



Generation 1
[2005 – 2011]
IAC : 25 kA / 1s



Generation 2
[2011- Present]
IAC : 31.5 kA / 0.1s & 25 kA / 1 s



Generation 3
[2014 – Present]
IAC : 31.5 kA / 1s & 31.5 kA / 0.1s

General Arrangement Drawing – Standard Panel

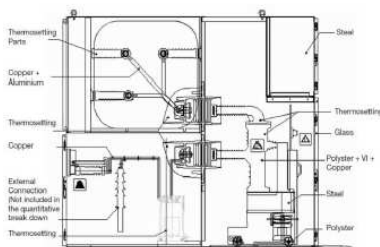

Generation 1
[2005 – 2011]
IAC : 25 kA / 1s

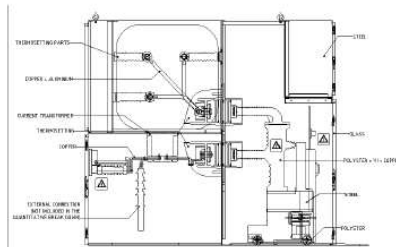

Generation 2
[2011- Present]
IAC : 31.5 kA / 0.1s

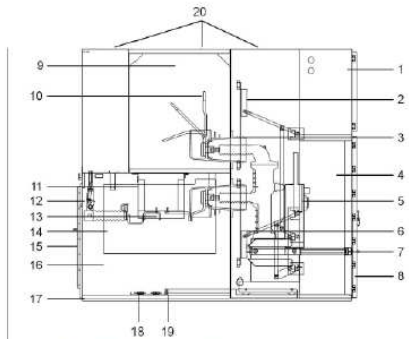

Generation 3
[2014 – Present]
IAC : 31.5 kA / 1s

- 1. Lowvoltage cabinet with control element
- 2. Main bus shunter for bus side
- 3. Spring
- 4. Circuit breaker component
- 5. Circuit breaker INSUL
- 6. Main bus shunter of cable side
- 7. Guide rails
- 8. Front door
- 9. Insulator component
- 10. Current transformers
- 11. Earth switch
- 12. Cable connection
- 13. Frame support
- 14. Main bus
- 15. Cable compartment
- 16. Base frame
- 17. Cable frame assembly
- 18. Main bus
- 19. Insulator roller/legs
- 20. Riser

MV Switchgear Spares

Interface Evolution on Cubicle Front Door



Generation 1

•Cubicle door is lifting and rotating type with lifting handle.

•The racking handle is inserting through a opening in the cubicle door to rotate the shaft of the gear box on the moving part.



Generation 2

•Cubicle door is lifting and rotating type with lifting handle.

•The projected channel on the front door houses the racking nut as well as the racking screw.



Generation 3

•Cubicle door is only rotating type with rotating handle.

•The operating handle operates multiple point rods.

•The racking handle is inserting into the trolley by operating a slider on the cubicle door.

Racking Arrangement Evolution in HVX- O



Generation 1

•CB is having a racking module consisting of racking arms, spur gears and gear box. The shaft of the gear box is to be rotated for racking in/out the breaker.



Generation 2

•CB is having a sheet bracket & is racked in/out by means of a screw situated on cubicle front door and driving the sheet bracket.



Generation 3

•CB is having racking screw which is part of the trolley. The trolley is locked inside the cubicle.

Isolating Contacts Evolution in HVX - O

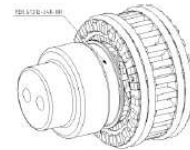

Generation 1

Generation 2

Generation 3

- For 2000A – Tulip contact with 30 fingers with 2 hole fixing
- For 1600A – Tulip contact with 24 fingers with 2 hole fixing
- For 1250 A – Tulip contact with 24 fingers with 2 hole fixing
 - Chinese Tulip contact with 12 fingers with 1 hole fixing

- For 2000A – Tulip contact with 30 fingers with 2 hole fixing
- For 1600A – Tulip contact with 24 fingers with 2 hole fixing
- For 1250 A – Chinese Tulip contact with 12 fingers with 1 hole fixing
 - Horizontal finger arrangement

- For 2000A – Tulip contact with 24 fingers with 2 hole fixing
- For 1250 A – Vertical finger arrangement







PIX-36 Generation-1

PIX-36 Generation 1

Item Identification	Variants	Discription	Part code	Qty Per VCB (no)	Plant Name	Plant code
Floor Rolling Trolley						
	Breaker floor Wheel with Hardware	Wheel - Nylon	MVIA00054-01	4	Ecofit	IN66
	Gear Assembly (old rack-in)	Gear Assembly	MVIA00099-01	1	Ecofit	IN66
	Scrape Earthing Assy with Hardware	Earth contact Assembly	MVIA00120-01	1	Ecofit	IN66
Pole assembly						
	36kV-25kA-1250A Standard tulip	Pole assembly 25kA-1250A Standard tulip	VDRA00198-14	3	Ecofit	IN66
	36kV-31.5kA-1250A standard tulip	Pole assembly 31.5kA-1250A standard tulip	VDRA00198-15	3	Ecofit	IN66
	36kV-25kA-2000A	Pole assembly 25kA-2000A	VDRA00198-12	3	Ecofit	IN66
	36kV-31.5kA-2000A	Pole assembly 31.5kA-2000A	VDRA00198-13	3	Ecofit	IN66
	36kV-25kA-1250A With chinese tulip	Pole assembly 25kA-1250A With chinese tulip	VDRA00198-18	3	Ecofit	IN66
	36kV-31.5kA-1250A With chinese tulip	Pole assembly 31.5kA-1250A With chinese tulip	VDRA00198-19	3	Ecofit	IN66
	Pole assembly for UTX With chinese tulip-36kV-25kA-1250A	Pole assembly for UTX With chinese tulip 25kA-1250A	MVIA00117-05	3	Ecofit	IN66
	Pole assembly for UTX With Standard tulip-36kV-25kA-2000A	Pole assembly for UTX With Standard tulip 25kA-2000A	MVIA00117-06	3	Ecofit	IN66
Isolating contacts						
	Tulip contact for 36kV-25kA/31.5 kA -2500A(30 fingers and 2 hole fixing)	Tulip contact 25/31.5kA -2500A(30 fing+2 hole)	MVIA00121-02	6	Ecofit	IN66
	Tulip contact for 36KV-25KA/31.5KA-1600A / 1250A (standard tulip with 24 fingers and 2 hole fixing)	Tulip contact 25/31.5kA -1600A(24 fing+2 hole)	MVIA00121-01	6	Ecofit	IN66
	Tulip for 36KV-25kA/31.5 kA -1250A (12 fingers & 1 hole fixing)	Tulip contact 25/31.5kA -1250A(12fing+1 hole)	MVIA00121-04	6	Ecofit	IN66
Deflector						
	For 36KV-25kA/31.5 kA -2000A	Deflector 36KV-25kA/31.5kA -2000A	MVIA00052-02	6	Ecofit	IN66
	For Standard tulip - 36 kV- 1250 A/1600A - 25 kA/31.5 kA	Deflector standard 36KV-25kA/31.5kA -1250/1600A	MVIA00052-01	6	Ecofit	IN66
	For chinese tulip - 36 kV- 1250 A - 25 kA/31.5 kA	Deflector chinese 36KV-25kA/31.5kA -1250A	MVIA00052-03	6	Ecofit	IN66
Mechanism						
	Bearing Block	BEARING BLOCK OUTLINING	AGSH30411-02	1	Ecofit	IN66
	Spur Gear	Spur Gear	VDRP00020-01_S	1	Ecofit	IN66
	Operation Counter	Operation Counter	VDRP00021-01	1	Ecofit	IN66
	Spring Drum Assembly	Spring Drum Assembly	VDRP00023-01	1	Ecofit	IN66

Item Identification	Variants	Discription	Part code	Qty Per VCB (no)	Plant Name	Plant code
	Complete Primary shaft of mechanism	Complete Primary shaft of mechanism	AGSH36730-03_S	1	Ecofit	IN66
	Cam Disc	Cam Disc	AGSH30305-01	6	Ecofit	IN66
	Ramphook	Ramphook Assembly	VDRP00022-01	1	Ecofit	IN66
	PUSH BUTTON- On	PUSH BUTTON- On	MVIA00252-01	1	Ecofit	IN66
	PUSH BUTTON- Off	PUSH BUTTON- Off	MVIA00253-01	1	Ecofit	IN66
	Glide	Glide	AGSH30469-01	1	Ecofit	IN66
	Operating mechanism w/o closing/tripping/undervoltage coil and motor	Operating mech w/o closing/tripping/UV coil+motor	AGSH36740-03_S	1	Ecofit	IN66
Electrical Components						
Closing & Tripping Coils assembly with hardwares						
	220 VDC	Close/Trip coil 220VDC	AGSH31481-01L	2	Ecofit	IN66
	110/125 VDC, 220/230 VAC	Close/Trip coil 110/125VDC 220/230VAC	AGSH31482-01L	2	Ecofit	IN66
	48/60 VDC, 110/120 VAC	Close/Trip coil 48/60VDC 110/120VAC	AGSH31483-01L	2	Ecofit	IN66
	24 VDC	Close/Trip coil 24VDC	AGSH31484-01L	2	Ecofit	IN66
Spring Charging Motor assembly with hardwares						
	24 VDC	Spring charging motor ass 24VDC	AHSH31999-01	1	Ecofit	IN66
	48 VDC	Spring charging motor ass 48VDC	AGSH33017-01	1	Ecofit	IN66
	60 VDC	Spring charging motor ass 60VDC	AGSH33017-01	1	Ecofit	IN66
	110/125 VDC	Spring charging motor ass 110/125VDC	AGSH33019-01	1	Ecofit	IN66
	220 VDC	Spring charging motor ass 220VDC	AGSH33020-01	1	Ecofit	IN66
	110 VAC	Spring charging motor ass 110VAC	AHSH31999-01	1	Ecofit	IN66
	230 VAC	Spring charging motor ass 230VAC	AGSH33020-01	1	Ecofit	IN66
Under-voltage release F4 assembly with hardwares						
	DC application					
	24 VDC	Under voltage release 24VDC	VDRP00051-01	1	Ecofit	IN66
	48 VDC	Under voltage release 48VDC	VDRP00051-02	1	Ecofit	IN66
	60 VDC	Under voltage release 60VDC	VDRP00051-03	1	Ecofit	IN66
	110 VDC	Under voltage release 110VDC	VDRP00051-04	1	Ecofit	IN66
	125 VDC	Under voltage release 125VDC	VDRP00051-05	1	Ecofit	IN66
	AC application					
	100 VAC	Under voltage release 100VAC	VDRP00051-07	1	Ecofit	IN66
	110 VAC	Under voltage release 110VAC	VDRP00051-07	1	Ecofit	IN66
	220 VAC	Under voltage release 220VAC	VDRP00051-08	1	Ecofit	IN66

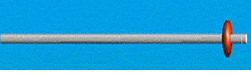

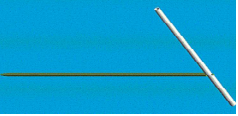
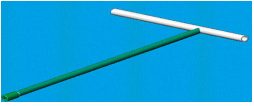
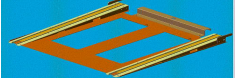
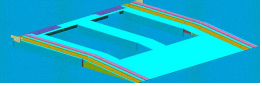

Item Identification	Variants	Discription	Part code	Qty Per VCB (no)	Plant Name	Plant code
	Auxiliary Switch 4NO/3NC	Auxiliary Switch 4NO/3NC	VDRP00024-01	1	Ecofit	IN66
	Motor cut-off switch 4NO/4NC	Motor cut-off switch 4NO/4NC	VDRP00024-02	2	Ecofit	IN66
Secondary Plug						
	64 Pin Plug and Socket Assembly (male+female combined)	64pin plug&socket(male+female)	VDRP00025-01	1	Ecofit	IN66
Front door - Accessories						
	Front Door Locking Handle	Front Door Locking Handle	VDRB05168-01	1 per panel	Ecofit	IN66
	Front Door Locking Handle with lock Rod	Front Door Locking Handle with lock Rod	VDRB05950-01	1 per panel	Ecofit	IN66
	Front Door Pulling handle	Front Door Pulling handle	ST424-121-001	1 per panel	Ecofit	IN66
Shutter						
	Shutter plate assembly	Shutter plate assembly	VDRB05299-01	2 per panel	Ecofit	IN66
	Rollers	Rollers	VDRB05950-06	2 per panel	Ecofit	IN66
	Spring packet assembly-Right	Spring packet assembly-Right	VDRB05950-07	1 per panel	Ecofit	IN66
	Spring packet assembly-Left	Spring packet assembly-Left	VDRB05950-08	1 per panel	Ecofit	IN66
	Spring packet-Right	Spring packet-Right	VDRB05217-01	1 per panel	Ecofit	IN66
	Spring packet-Left	Spring packet-Left	VDRB05217-02	1 per panel	Ecofit	IN66
Spout (without fixed contact)						
	Spout w/o fixed contact upto 2500A	Spout w/o fixed contact upto 2500A	MVIB00110-01	6 per panel	Ecofit	IN66
Front Deflector						
	I<=2000A	Front Deflector 2000A	VDRB05154-01	6 per panel	Ecofit	IN66
Accessories						
	Post Insulator	Post Insulator	MVIB00172-01	as required	Ecofit	IN66
	Capacitive insulator(live line indicator)	Capacitive insulator(live line indicator)	MVIB00172-02	as required	Ecofit	IN66

Item Identification	Variants	Discription	Part code	Qty Per VCB (no)	Plant Name	Plant code
	Breaker Rack - In/Rack Out handle	Breaker Rack - In/Rack Out handle	VDRG00157-02	as required	Ecofit	IN66
	Spring charging handle	Spring charging handle	MVIA00207-01	as required	Ecofit	IN66
	Breaker ON&OFF Rod-Emergency operation	Breaker ON&OFF Rod-Emergency operation	MVIB00775-01	as required	Ecofit	IN66
	Earthing Switch operating handle-Standard	Earthing Switch operating handle-Standard	VDRB05405-01	as required	Ecofit	IN66
	Earthing Switch operating handle - Extended	Earthing Switch operating handle-Extended	VDRB05405-02	as required	Ecofit	IN66
	Earthing Truck handle	Earthing Truck handle	MVIA00271-01	as required	Ecofit	IN66
	Breaker RAMP Assembly 25mm base frame	Breaker RAMP Assembly 25mm base frame	VDRB05526-03_S	as required	Ecofit	IN66
	VT Ramp	VT Ramp	VDRB05526-04_S	as required	Ecofit	IN66



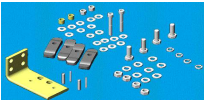
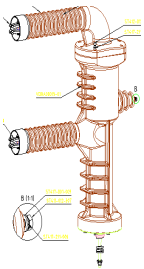
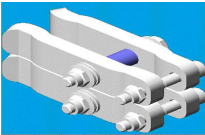
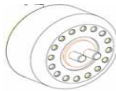

PIX-36 Generation-2

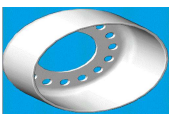
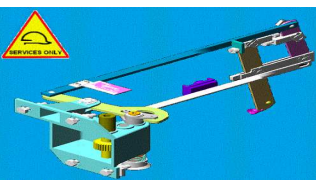

PIX-36 Generation 2

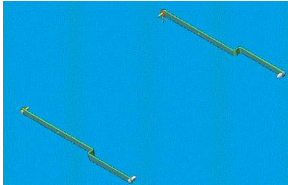
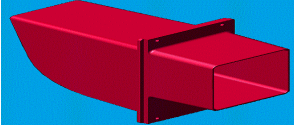
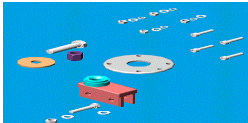
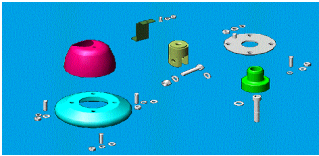
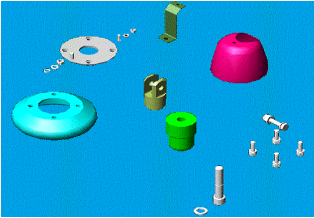
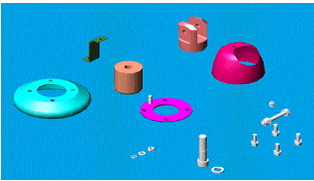

Item Identification	Variants	Discription	Part code	Qty Per VCB (no)	Plant Name	Plant code
Floor Rolling Trolley						
	Breaker floor Wheel with Hardware	Wheel - Nylon	MVIA00054-01	4	Ecofit	IN66
	Scrape Earthing Assy with Hardware	Earth contact Assembly	MVIA00120-01	1	Ecofit	IN66
Pole assembly						
	Pole assembly with horizontal finger type isolating contact - 36kV-25kA-1250A	Pole Assembly 25KA-1250A Horizontal finger type	VDRA00198-16	3	Ecofit	IN66
	Pole assembly with horizontal finger type isolating contact - 36kV-31.5kA-1250A	Pole Assembly 31.5KA-1250A Horizontal finger type	VDRA00198-17	3	Ecofit	IN66
	Pole assembly with tulip isolating contact - 36kV-25kA-2000A	Pole Assembly 25KA-2000A Tulip isolating	VDRA00198-12	3	Ecofit	IN66
	Pole assembly with tulip isolating contact - 36kV-31.5kA-2000A	Pole Assembly 31.5KA-2000A Tulip isolating	VDRA00198-13	3	Ecofit	IN66
	Pole assembly With chinese tulip contact -36kV-25kA-1250A	Pole Assembly 25KA-1250A Tulip contact	VDRP00117-07	3	Ecofit	IN66
	pole assembly With chinese tulip contact - 36kV-31.5kA-1250A	Pole Assembly 31.5KA-1250A Tulip contact	VDRP00117-06	3	Ecofit	IN66
Isolating contacts						
Isolating Contact - FlatType						
	36KV-25kA-1250A	Isolating contact Flat type 25KA 1250A	VDRA00014-03	12	Ecofit	IN66
	36KV-31.5kA-1250A	Isolating contact Flat type 31.5KA 1250A		12	Ecofit	IN66
Tulip contact for 2000A (30 fingers & 2 hole fixing)						
	36kV-25kA-2000A	Tulip contact 25KA 2000A	MVIA00121-02	6	Ecofit	IN66
	36kV-31.5kA-2000A	Tulip contact 31.5KA 2000A		6	Ecofit	IN66
Tulip contact for 1250A(12 fingers & 1 hole fixing)						
	36KV-25kA-1250A	Tulip contact 25KA 1250A	MVIA00121-04	6	Ecofit	IN66
	36KV-31.5kA-1250A	Tulip contact 31.5KA 1250A		6	Ecofit	IN66
Deflector						
	Deflector for Flat type isolating contact-36KV-1250A-25 kA/31.5kA	Deflector upto 1250A-31.5KA-Flat type	MVIA00052-04	6	Ecofit	IN66
	Deflector for Tulip-36KV-1250A-25 kA/31.5 kA	Deflector upto 1250A-31.5KA-Tulip type	MVIA00052-03	6	Ecofit	IN66
	Deflector Tulip-36KV-2000A-25kA/31.5 kA	Deflector upto 2000A-31.5KA-Tulip type	MVIA00052-02	6	Ecofit	IN66
Mechanism						
	Bearing Block	BEARING BLOCK OUTLINING	AGSH30411-02	1	Ecofit	IN66

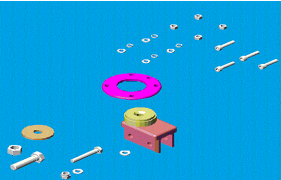
Item Identification	Variants	Discription	Part code	Qty Per VCB (no)	Plant Name	Plant code
	Spur Gear	Spur Gear	VDRP00020-01_S	1	Ecofit	IN66
	Operation Counter	Operation Counter	VDRP00021-01	1	Ecofit	IN66
	Spring Drum Assembly	Spring Drum Assembly	VDRP00023-01	1	Ecofit	IN66
	Complete Primary shaft of mechanism	Complete Primary shaft of mechanism	AGSH36730-03_S	1	Ecofit	IN66
	Cam Disc	Cam Disc	AGSH30305-01	6	Ecofit	IN66
	Ramphook	Ramphook Assembly	VDRP00022-01	1	Ecofit	IN66
	PUSH BUTTON- On	PUSH BUTTON- On	MVIA00252-01	1	Ecofit	IN66
	PUSH BUTTON- Off	PUSH BUTTON- Off	MVIA00253-01	1	Ecofit	IN66
	Glide	Glide	AGSH30469-01	1	Ecofit	IN66
	Operating mechanism w/o closing/tripping/undervoltage coil and motor	Operating mech w/o closing/tripping/UV coil+motor	AGSH36740-03_S	1	Ecofit	IN66
Electrical Components						
Closing & Tripping Coils assembly with hardwares						
	220 VDC	Close/Trip coil 220VDC	AGSH31481-01L	2	Ecofit	IN66
	110/125 VDC, 220/230 VAC	Close/Trip coil 110/125VDC 220/230VAC	AGSH31482-01L	2	Ecofit	IN66
	48/60 VDC, 110/120 VAC	Close/Trip coil 48/60VDC 110/120VAC	AGSH31483-01L	2	Ecofit	IN66
	24 VDC	Close/Trip coil 24VDC	AGSH31484-01L	2	Ecofit	IN66
Spring Charging Motor assembly with hardwares						
	24 VDC	Spring charging motor ass 24VDC	AGSH31999-01	1	Ecofit	IN66
	48 VDC	Spring charging motor ass 48VDC	AGSH33017-01	1	Ecofit	IN66
	60 VDC	Spring charging motor ass 60VDC	AGSH33017-01	1	Ecofit	IN66
	110/125 VDC	Spring charging motor ass 110/125VDC	AGSH33019-01	1	Ecofit	IN66
	220 VDC	Spring charging motor ass 220VDC	AGSH33020-01	1	Ecofit	IN66
	110 VAC	Spring charging motor ass 110VAC	AGSH31999-01	1	Ecofit	IN66
	230 VAC	Spring charging motor ass 230VAC	AGSH33020-01	1	Ecofit	IN66
Under-voltage release F4 assembly with hardwares						
	DC application					
	24 VDC	Under voltage release 24VDC	VDRP00051-01	1	Ecofit	IN66
	48 VDC	Under voltage release 48VDC	VDRP00051-02	1	Ecofit	IN66
	60 VDC	Under voltage release 60VDC	VDRP00051-03	1	Ecofit	IN66
	110 VDC	Under voltage release 110VDC	VDRP00051-04	1	Ecofit	IN66

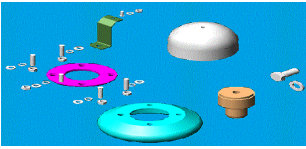
Item Identification	Variants	Discription	Part code	Qty Per VCB (no)	Plant Name	Plant code
	125 VDC	Under voltage release 125VDC	VDRP00051-05	1	Ecofit	IN66
	220 VDC	Under voltage release 220VDC	VDRP00051-06	1	Ecofit	IN66
	AC application					
	100 VAC	Under voltage release 100VAC	VDRP00051-07	1	Ecofit	IN66
	110 VAC	Under voltage release 110VAC	VDRP00051-07	1	Ecofit	IN66
	Auxiliary Switch 4NO/3NC	Auxiliary Switch 4NO/3NC	VDRP00024-01	1	Ecofit	IN66
	Motor cut-off switch 4NO/4NC	Motor cut-off switch 4NO/4NC	VDRP00024-02	2	Ecofit	IN66
Secondary Plug						
	64 Pin Plug and Socket Assembly (male+female combined)	64pin plug&socket(male+female)	VDRP00025-01	1	Ecofit	IN66
Rack In-Out Bracket on Trolley						
	Bracket	Bracket	MVIA00085-01	1	Ecofit	IN66
Circuit Breaker chamber						
Front door - Accessories						
	Front Door Handle Locking assembly	Front Door Handle Locking assembly	MVIB00088-03	1 per panel	Ecofit	IN66
	Front Door Pulling handle	Front Door Pulling handle	ST424-121-001	1 per panel	Ecofit	IN66
Shutter						
	Shutter assembly with rollers for HVX/UTX/MTX	Shutter assembly with rollers for HVX/UTX/MTX	MVIB00096-02	2 per panel 10-MOQ	Ecofit	IN66
	Shutter assembly with rollers for MTX(Line PT)	Shutter assembly with rollers for MTX(Line PT)	VDRB00950-05	1 per panel 10-MOQ	Ecofit	IN66
	Shutter SMC guide	Shutter SMC guide	VDRB00950-06	4 per panel 10-MOQ	Ecofit	IN66
	Shutter Linkage assembly for HVX/UTX	Shutter Linkage assembly for HVX/UTX	VDRB00950-07	1 per panel 10-MOQ	Ecofit	IN66

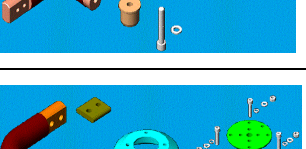
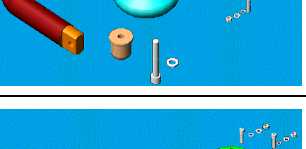
Item Identification	Variants	Discription	Part code	Qty Per VCB (no)	Plant Name	Plant code
	Shutter Linkage assembly for MTX(Bus PT/Line PT)	Shutter Linkage assembly for MTX(Bus PT/Line PT)	VDRB00950-08	1 per panel 10-MOQ	Ecofit	IN66
Spout (without fixed contact)						
	Spout w/o fixed contact upto 2500A	Spout w/o fixed contact upto 2500A	MVIB001110-01	6 per panel	Ecofit	IN66
Busbar Side Contact Assembly						
	I<=1250A MTX	Busbar side contact assembly 1250A MTX	VDRB00950-10	3 per panel	Ecofit	IN66
	I<=1250A MTX in Riser	Busbar side contact assembly 1250A MTX in Riser	VDRB00950-11	3 per panel	Ecofit	IN66
	I<=1250A No M.P	Busbar side contact assembly 1250A M.P	VDRB00950-12	3 per panel	Ecofit	IN66
	I<=1250A HVX/UTX-Tulip Contact (35mm dia, Single Hole Tulip)	Busbar side 1250A HVX/UTX-Tulip Contact (35mm dia, Single Hole Tulip)	VDRB00950-13	3 per panel	Ecofit	IN66
	I <= 1250A HVX/UTX-Tulip Contact (50mm dia,Two Hole Tulip)	Busbar side 1250A HVX/UTX-Tulip Contact (50mm dia, Single Hole Tulip)	VDRB00950-14	3 per panel	Ecofit	IN66
	I=1600A HVX/UTX	Busbar sie 1600A HVX/UTX	VDRB00950-14	3 per panel	Ecofit	IN66
	I=2000A HVX / UTX	Busbar side 2000A HVX/UTX	VDRB00950-15	3 per panel	Ecofit	IN66
	1250A<I<=2000A MTX	Busbar side 1250A<I<=2000A MTX	VDRB00950-16	3 per panel	Ecofit	IN66
	1250A<I<=2000 MTX in Riser	Busbar side 1250A<I<=2000 MTX in Riser	VDRB00950-17	3 per panel	Ecofit	IN66
Circuit Side Contact Assembly						

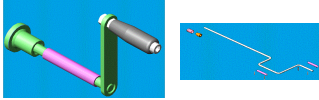
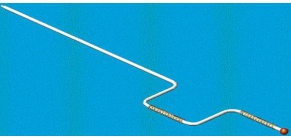
Item Identification	Variants	Discription	Part code	Qty Per VCB (no)	Plant Name	Plant code
	I<=1250A HVX/UTX-Tulip Contact(35mm dia,Single Hole Tulip),Feeder,Single CT	Circuit side I<=1250A HVX/UTX-Tulip Contact(35mm dia,Single Hole Tulip),Feeder,Single CT	VDRB00950-24	3 per panel	Ecofit	IN66
	I<=1250A HVX-Tulip Contact(35mm dia, Single Hole Tulip), Feeder, Two CT	Circuit side I<=1250A HVX-Tulip Contact(35mm dia, Single Hole Tulip),Feeder,Two CT	VDRB00950-25	3 per panel	Ecofit	IN66
	I<=1250A HVX/UTX-Tulip Contact(50mm dia,Two Hole Tulip),Feeder,Single CT	Circuit side I<=1250A HVX/UTX-Tulip Contact(50mm dia,Two Hole Tulip),Feeder,Single CT	VDRB00950-26	3 per panel	Ecofit	IN66
	1250A<I<=1600A HVX-Tulip Contact(50mm dia,Two Hole Tulip),Feeder,Two CT	Circuit side 1250A<I<=1600A HVX-Tulip Contact(50mm dia,Two Hole Tulip),Feeder,Two CT	VDRB00950-27	3 per panel	Ecofit	IN66
	1250A<I<=1600A HVX/UTX-Tulip Contact, Feeder, Single CT	Circuit side 1250A<I<=1600A HVX/UTX-Tulip Contact, Feeder, Single CT	VDRB00950-26	3 per panel	Ecofit	IN66
	1250A<I<=1600A HVX-Tulip Contact,Feeder,Two CT	Circuit Side 1250A<I<=1600A HVX-Tulip Contact,Feeder,Two CT	VDRB00950-27	3 per panel	Ecofit	IN66
	1600A<I<=2000A HVX/UTX-Tulip Contact, Feeder, Single CT	Circuit side 1600A<I<=2000A HVX/UTX-Tulip Contact, Feeder, Single CT	VDRB00950-28	3 per panel	Ecofit	IN66
	1600A<I<=2000A HVX-Tulip Contact,Feeder,Two CT	Circuit side 1600A<I<=2000A HVX-Tulip Contact,Feeder,Two CT	VDRB00950-29	3 per panel	Ecofit	IN66
Accessories						
	Post Insulator	Post Insulator	MVIB00172-01	as required	Ecofit	IN66
	Capacitive insulator(live line indicator)	Capacitive insulator(live line indicator)	MVIB00172-02	as required	Ecofit	IN66

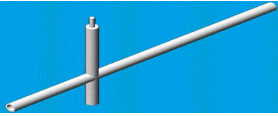
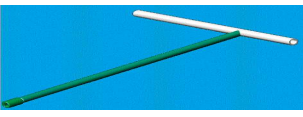
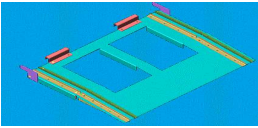
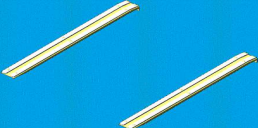

Item Identification	Variants	Discription	Part code	Qty Per VCB (no)	Plant Name	Plant code
	Breaker Rack - In/ Rack Out handle	Breaker Rack - In/Rack Out handle	MVIA00204-01	as required	Ecofit	IN66
	Spring charging handle	Spring charging handle	MVIA00207-01	as required	Ecofit	IN66
	Breaker ON&OFF rod for emergency operation	Breaker ON&OFF Rod-Emergency operation	MVIB00775-01	as required	Ecofit	IN66
	Earthing Switch operating handle-Standard	Earthing Switch operating handle-Standard	MVIB00358-01	as required	Ecofit	IN66
	Earthing Switch operating handle-Side Entry	Earthing Switch operating handle-Side Entry	MVIB00358-02	as required	Ecofit	IN66
	Earthing Truck handle	Earthing Truck handle	MVIA00271-01	as required	Ecofit	IN66
	CB Ramp	CB Ramp	VDRB00296-06	as required	Ecofit	IN66
	VT Ramp - Horizontal VT	VT Ramp - Horizontal VT	MVIB00762-01	as required	Ecofit	IN66







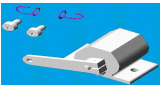
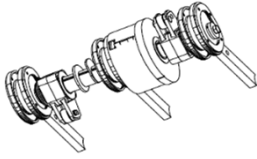
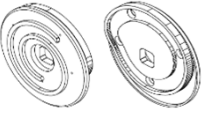

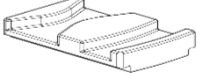
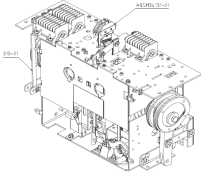
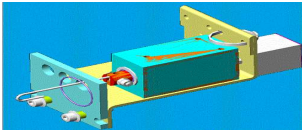
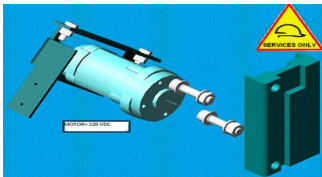
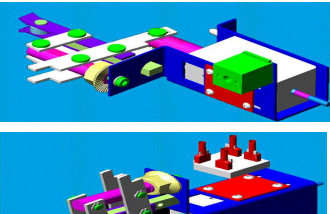
PIX-36 Generation-3

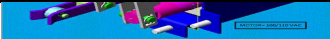
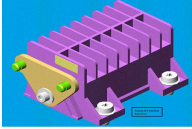
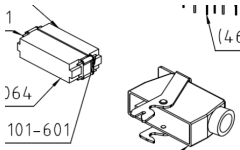
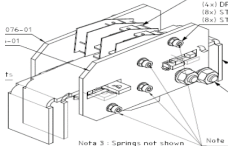
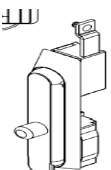
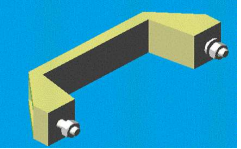
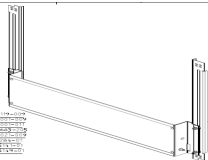
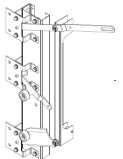
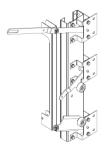
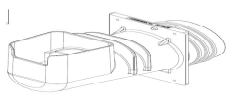
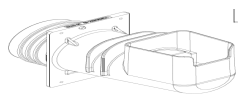
PIX-36 Generation 3

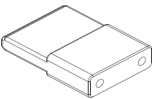
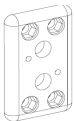
Item Identification	Variants	Discription	Part code	Qty Per VCB (no)	Plant Name	Plant code
Floor Rolling Trolley-VDRA00122-01						
	Breaker floor Wheel with Hardware	Breaker floor Wheel with Hardware	VDRP00145-01	4	VDR	IN58
	Scrape Earthing Assy with Hardware	Scrape Earthing Assy with Hardware	VDRP00143-01	1	VDR	IN58
Pole assembly						
	Pole assembly with vertical finger type isolating contact-36kV-26.3kA-1250A	Pole assembly with vertical finger type isolating contact-36kV-26.3kA-1250A	VDRP00198-01	3	VDR	IN58
	Pole assembly with Tulip contact-36kV-26.3kA-2000A	Pole assembly with Tulip contact-36kV-26.3kA-2000A	VDRP00198-02	3	VDR	IN58
	Pole assembly with vertical finger type isolating contact-36kV-31.5kA-1250A	Pole assembly with vertical finger type isolating contact-36kV-31.5kA-1250A	VDRP00198-03_S	3	VDR	IN58
	Pole assembly with tulip contact-36kV-31.5kA-2000A	Pole assembly with tulip contact-36kV-31.5kA-2000A	VDRP00198-04	3	VDR	IN58
	Pole assembly for UTX(Metering Truck)	Pole assembly for UTX(Metering Truck)	VDRA00198-05	3	VDR	IN58
Isolating contacts						
	Isolating Contact-Vertical Finger Type-36kV-26.3kA-1250A	Isolating Contact-Vertical Finger Type-36kV-26.3kA-1250A	VDRA00071-01	6	VDR	IN58
	Isolating Contact-Tulip Type(24 fingers)-36kV-26.3kA-2000A	Isolating Contact-Tulip Type(24 fingers)-36kV-26.3kA-2000A	VDRP00073-01	6	VDR	IN58
	Isolating Contact-Vertical Finger Type-36kV-31.5kA-1250A	Isolating Contact-Vertical Finger Type-36kV-31.5kA-1250A	VDRA00071-01	6	VDR	IN58
	Isolating Contact -Tulip Type(24 fingers)-36kV-31.5kA-2000A	Isolating Contact -Tulip Type(24 fingers)-36kV-31.5kA-2000A	VDRP00073-01	6	VDR	IN58
Deflector						
	Deflector with vertical finger type isolating contact arrangement(4 fingers) - 1250 A	Deflector with vertical finger type contact-1250A	MVIA00052-04	6	VDR	IN58
	Deflector with Tulip type isolating contact of 2000A	Deflector with tulip type contact-2000A	VDRA00311-01	6	VDR	IN58
Pole bottom - snatch gap adjustment						
	Adjustable Spacer for 1250/2000A-26.3kA	Adjustable Spacer for 1250/2000A-26.3kA	VDRA00182-03	3	VDR	IN58
	Adjustable Spacer for 1250/2000A-31.5kA	Adjustable Spacer for 1250/2000A-31.5kA	VDRA00182-04	3	VDR	IN58
Mechanism						
	Bearing Block	BEARING BLOCK OUTLINING	AGSH30411-02	1	VDR	IN58

Item Identification	Variants	Discription	Part code	Qty Per VCB (no)	Plant Name	Plant code
	Spur Gear	Spur Gear	VDRP00020-01_S	1	VDR	IN58
	Operation Counter	Operation Counter	VDRP00021-01	1	VDR	IN58
	Spring Drum Assembly	Spring Drum Assembly	VDRP00023-01	1	Ecofit	IN66
	Complete Primary shaft of mechanism	Complete Primary shaft of mechanism	AGSH36730-03_S	1	Ecofit	IN66
	Cam Disc	Cam Disc	AGSH30305-01	6	VDR	IN58
	Ramphook	Ramphook Assembly	VDRP00022-01	1	VDR	IN58
	PUSH BUTTON-On and off	PUSH BUTTON-On and off	VDRP00310-01	2	VDR	IN58
	Glide	Glide	AGSH30469-01	1	VDR	IN58
	operating mechanism w/o closing/tripping/undervoltage coil and motor	Operating mech w/o closing/tripping/UV coil+motor	VDRP00250-01	1	VDR	IN58
Electrical Components						
Closing & Tripping Coils assembly with hardwares						
	220 VDC	Close/Trip coil 220VDC	VDRP00001-01	2	VDR	IN58
	110/125 VDC,220/230 VAC	Close/Trip coil 110/125VDC 220/230VAC	VDRP00002-01	2	VDR	IN58
	48/60 VDC,110/120 VAC	Close/Trip coil 48/60VDC 110/120VAC	VDRP00003-01	2	VDR	IN58
	24 VDC	Close/Trip coil 24VDC	VDRP00004-01	2	VDR	IN58
Spring Charging Motor assembly with hardwares						
	24 VDC	Spring charging motor ass 24VDC	VDRP00005-01	1	VDR	IN58
	48 VDC	Spring charging motor ass 48VDC	VDRP00006-01	1	VDR	IN58
	60 VDC	Spring charging motor ass 60VDC	VDRP00007-01	1	VDR	IN58
	110/125 VDC	Spring charging motor ass 110/125VDC	VDRP00008-01	1	VDR	IN58
	220 VDC	Spring charging motor ass 220VDC	VDRP00009-01	1	VDR	IN58
	110 VAC	Spring charging motor ass 110VAC	VDRP00010-01	1	VDR	IN58
	230 VAC	Spring charging motor ass 230VAC	VDRP00011-01	1	VDR	IN58
Under-voltage release F4 assembly with hardwares						
	DC application					
	24 VDC	Under voltage release 24VDC	VDRP00051-01	1	VDR	IN58
	48 VDC	Under voltage release 48VDC	VDRP00051-02	1	VDR	IN58
	60 VDC	Under voltage release 60VDC	VDRP00051-03	1	VDR	IN58
	110 VDC	Under voltage release 110VDC	VDRP00051-04	1	VDR	IN58
	125 VDC	Under voltage release 125VDC	VDRP00051-05	1	VDR	IN58
	220 VDC	Under voltage release 220VDC	VDRP00051-06	1	VDR	IN58
	AC application					
100 VAC	Under voltage release 100VAC	VDRP00051-07	1	VDR	IN58	

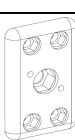
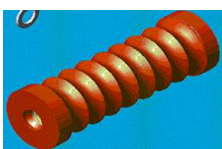
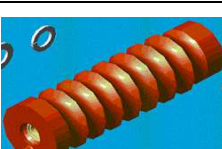
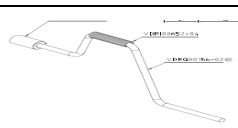
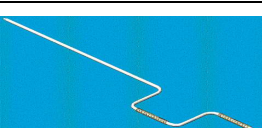
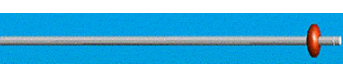
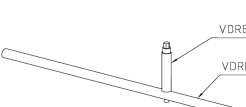
Item Identification	Variants	Discription	Part code	Qty Per VCB (no)	Plant Name	Plant code
	110 VAC	Under voltage release 110VAC	VDRP00051-07	1	VDR	IN58
	220 VAC	Under voltage release 220VAC	VDRP00051-08	1	VDR	IN58
	Auxiliary Switch 4NO/3NC	Auxiliary Switch 4NO/3NC	VDRP00024-01	1	VDR	IN58
	Motor cut-off switch 4NO/4NC	Motor cut-off switch 4NO/4NC	VDRP00024-02	2	VDR	IN58
Secondary Plug						
	64 Pin Plug and Socket Assembly (male+female combined)	64pin plug&socket(male+female)	VDRP00025-01	1	VDR	IN58
Racking Trolley						
	Microswitch Assy	Microswitch Assy	VDRP00120-01	1	VDR	IN58
Circuit Breaker chamber						
Front door - Accessories						
	Front Door Handle assembly	Front Door Handle assembly	VDRB05168-01	1 per panel	VDR	IN58
	Front Door Pulling handle	Front Door Pulling handle	ST424-121-001	1 per panel	VDR	IN58
Shutter						
	Shutter with guide assembly for breaker panel	Shutter with guide assembly for breaker panel	VDRB05299-01	2 per panel	VDR	IN58
	Shutter with guide assembly MTX/ETX	Shutter assembly with rollers for MTX/ETX	VDRB05299-01	1 per panel	VDR	IN58
	LHS Shutter Linkage assembly for breaker panel	LHS Shutter Linkage assembly for breaker panel	VDRB05297-01	1 per panel	VDR	IN58
	RHS Shutter Linkage assembly for breaker panel	RHS Shutter Linkage assembly for breaker panel	VDRB05297-02	1 per panel	VDR	IN58
Spout (without fixed contact)						
	I<=1250A	Spout w/o fixed contact 1250A	VDRB05001-01	6 per panel	VDR	IN58
	1250<I<=2500A	Spout w/o fixed contact 1250<I<=2500A	VDRB05001-02	6 per panel	VDR	IN58
Busbar & Circuit Contact Assembly						

Item Identification	Variants	Discription	Part code	Qty Per VCB (no)	Plant Name	Plant code
	Busbar/Circuit spout contact upto 1250A (Breaker & MTX) Applicable for both Aluminium and copper riser	Busbar/Circuit spout contact upto 1250A (Breaker & MTX)	VDRB05008-01	6 per panel	VDR	IN58
	Busbar/Circuit clamp upto 1250A (Breaker & MTX) Applicable for both Aluminium and copper riser	Busbar/Circuit clamp upto 1250A (Breaker & MTX)	VDRB05155-01	6 per panel	VDR	IN58
	Busbar/Circuit Deflector upto 1250A (Breaker & MTX) Applicable for both Aluminium and copper riser	Busbar/Circuit Deflector upto 1250A (Breaker & MTX)	VDRB05154-01	6 per panel	VDR	IN58
	Busbar/Circuit Plug In connection 2000A Applicable for both Aluminium and copper riser	Busbar/Circuit Plug In connection 2000A	VDRB05012-01	6 per panel	VDR	IN58
	Busbar/Circuit Plug In connection 2500A Applicable for both Aluminium and copper riser	Busbar/Circuit Plug In connection 2500A	VDRB05012-02	6 per panel	VDR	IN58
	Busbar/Circuit Deflector 2000/2500A Applicable for both Aluminium and copper riser	Busbar/Circuit Deflector 2000/2500A	VDRB05154-02	6 per panel	VDR	IN58
	Busbar/Circuit side clamp 2000/2500A Applicable for both Aluminium and copper riser	Busbar/Circuit side clamp 2000/2500A	VDRB05155-02	6 per panel	VDR	IN58
Accessories						
	Insulator	Insulator	MVIB00172-01	as required	VDR	IN58
	Capacitive insulator(live line indicator)	Capacitive insulator(live line indicator)	MVIB00172-02	as required	VDR	IN58
	Breaker Rack In/Rack Out handle-Standard	Breaker Rack In/Rack Out handle-Standard	VDRG00157-02	as required	VDR	IN58
	Spring charging handle	Spring charging handle	MVIA00207-01	as required	VDR	IN58
	Breaker ON&OFF Rod-emergency operation	Breaker ON&OFF Rod-Emergency operation	MVIB00775-01	as required	VDR	IN58
	Earthing Switch operating handle-Standard	Earthing Switch operating handle-Standard	VDRB05405-01	as required	VDR	IN58
	Earthing Switch operating handle-Extended	Earthing Switch operating handle-Extended	VDRB05405-02	as required	VDR	IN58

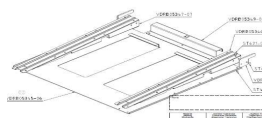
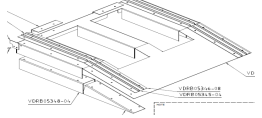
Item Identification	Variants	Discription	Part code	Qty Per VCB (no)	Plant Name	Plant code
	Earthing Truck handle	Earthing Truck handle	VDRA00911-01	as required	VDR	IN58
	Breaker Ramp	Breaker Ramp	VDRB05526-03_S	as required	VDR	IN58
	VT Ramp	VT Ramp	VDRB05526-04_S	as required	VDR	IN58





PIX

**Air-insulated switchgear PIX
with Roll on Floor Circuit Breaker**

PIX-ROF

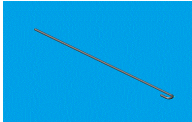
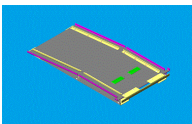

Item Identification	Variants	Part code	Qty Per VCB (no)	Plant Name	Plant code
FRONG DOOR - ACCESSORIES					
	Front Door Pulling Handle	VDRB05950-03_S	1	VDR	IN58
SHUTTER					
	Shutter plate assembly, 600mm	VDRI08000-03	1	VDR	IN58
	Shutter plate assembly, 800mm	VDRI08000-04	1	VDR	IN58
	Rollers	VDRI08000-05	1	VDR	IN58
COIL FOR SOLENOID INTERLOCKING					
	24 V AC/DC	ST436-101-230	1	VDR	IN58
	30 V AC/DC	ST436-101-234	1	VDR	IN58
	48 V AC/DC	ST436-101-238	1	VDR	IN58
	60 V AC/DC	ST436-101-241	1	VDR	IN58
	110 V AC/DC	ST436-101-248	1	VDR	IN58
	125 V AC/DC	ST436-101-251	1	VDR	IN58
	220DC/230V AC/DC(to check)	ST436-101-359	1	VDR	IN58
SPOUT ASSEMBLY					
	Busbar Spout Assembly, I<=800A	VDRI08000-06	1	VDR	IN58
	Busbar Spout Assembly, 800 A < I <= 1250 A	VDRI08000-07	1	VDR	IN58
	Busbar/Circuit Spout Assembly, 1250 A < I <= 2000 A	VDRI08000-08	3	VDR	IN58
	Busbar/Circuit Spout Assembly, 2000 A < I <= 2500 A	VDRI08000-09	3	VDR	IN58
	Busbar Spout Assembly, 2500 A < I <= 3150 A	VDRI08000-10	3	VDR	IN58
	Busbar/Circuit Spout Assembly, 2500 A < I <= 3150 A	VDRI08000-11	3	VDR	IN58
INSULATOR					
	Insulator for Voltage Indication, V <= 3.3 Kv	VDRI00170-03	1	VDR	IN58

Item Identification	Variants	Part code	Qty Per VCB (no)	Plant Name	Plant code
	Insulator for Voltage Indication, 3.6 kV < V <= 6.6 kV	VDRI00170-04	1	VDR	IN58
	Insulator for Voltage Indication, 6.6 kV < V <= 12 kV	VDRI00170-05	1	VDR	IN58
	Insulator for Voltage Indication, 12 kV < V <= 17.5kV	VDRI00170-01	1	VDR	IN58
Accessories					
	Earthing switch lever	VDRI00925-03	1	VDR	IN58
	Bar for Open-close operation with stick	AGSH35446-01	1	VDR	IN58
	Hand crank for charging the mechanism	AGSH30498-01	1	VDR	IN58
	Breaker Rack - In/ Rack Out handle	VDRG00157-02	1	VDR	IN58
	Ramp for Circuit Breaker for 600mm width	VDRI00760-01	1	VDR	IN58
	Ramp for Circuit Breaker for 800mm width	VDRI00760-02	1	VDR	IN58

HVX - ROF CB - 12kV,40kA,2000,2500 & 3150A

Item Identification	Variants	Part code	Qty Per VCB (no)	Plant Name	Plant code
ISOLATING CONTACT					
	Finger Type 2000A	VDRK00031-03	24	VDR	IN58
	Tulip Type (48 fingers) 2500A	VDRK00079-05	6	VDR	IN58
	Tulip Type (82 fingers) 3150A	VDRK00079-07	6	VDR	IN58
EQUIPPED ARMS ASSEMBLY					
	Stem Top 2000A	VDRK00030-01	3	VDR	IN58
	Stem Bottom 2000A	VDRK00029-01	3	VDR	IN58
	Stem Top and Bottom 2500A	DRCN02550-02	6	VDR	IN58
	Stem Top and Bottom 3150A	DRCN02551-03	6	VDR	IN58
VACUUM INTERRUPTER					
	12kV-40kA-2000A	VDRK00011-02	3	VDR	IN58
	12kV-40kA-2500A	VDRK00011-03	3	VDR	IN58

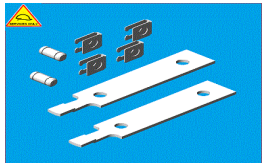
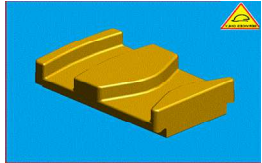
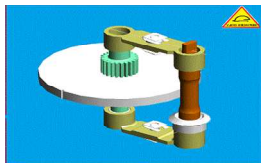
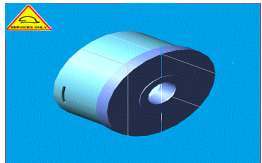
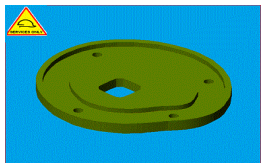
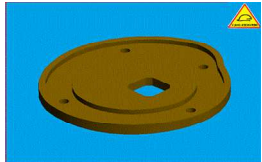
Item Identification	Variants	Part code	Qty Per VCB (no)	Plant Name	Plant code
	12kV-40kA-3150A	VDRK00011-04	3	VDR	IN58
FLOOR ROLLING TROLLEY					
	Breaker floor Rolling Wheel	MVIK00025-01	4	VDR	IN58
	Axle For Wheel	MVIK00066-01	4	VDR	IN58
	Scrap Earthing Assembly	MVIG00143-01	1	VDR	IN58
RACKING TROLLEY					
	Racking Trolley Assembly	VDRG00199-01	1	VDR	IN58
MECHANISM					
	Primary Shaft	AGSH36730-12	1	VDR	IN58
	Bearing Block	AGSH30411-02	1	VDR	IN58
	Spur Gear	VDRP00020-01	1	VDR	IN58
	Operation Counter	VDRP00021-01	1	VDR	IN58

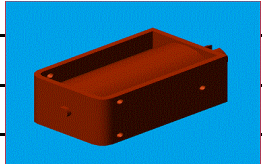
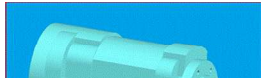
Item Identification	Variants	Part code	Qty Per VCB (no)	Plant Name	Plant code
	Ramphook	VDRP00022-01	1	VDR	IN58
	Glide	AGSH30469-01	1	VDR	IN58
	Main Gear	AGSH30481-01	1	VDR	IN58
	Spring Drum	AGSH30270-02	1	VDR	IN58
	Cam Disc (Right)	AGSH30276-01	3	VDR	IN58
	Cam Disc (Left)	AGSH30277-01	2	VDR	IN58
	Cam Washer	AGSH30305-01	1	VDR	IN58
CLOSING/TRIPPING COIL					
	24-30V DC	AGSH31484-01	2	VDR	IN58
	48 V DC	AGSH31483-01	2	VDR	IN58
	110 V DC	AGSH31482-01	2	VDR	IN58
	220 V DC	AGSH31481-01	2	VDR	IN58
UNDERVOLTAGE COIL					
	24V DC	AGSH34286-01	1	VDR	IN58
	48V DC	AGSH34286-02	1	VDR	IN58
	60V DC	AGSH34286-03	1	VDR	IN58
	110V DC	AGSH34286-04	1	VDR	IN58
	125V DC / 100-110V AC	AGSH34286-05	1	VDR	IN58
	220V DC / 230V AC	AGSH34286-06	1	VDR	IN58
SPRING CHARGING MOTOR					
	110V AC/DC	AGSH33019-01	1	VDR	IN58

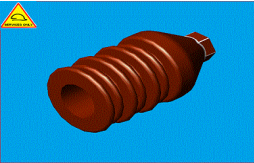
Item Identification	Variants	Part code	Qty Per VCB (no)	Plant Name	Plant code
	220V AC/DC	AGSH33020-01	1	VDR	IN58
INSULATOR ASSEMBLY					
	Drive Insulator	VDRK00037-01	3	VDR	IN58
HOUSING 12kV					
	Housing 12kV	DRC006259-01	3	VDR	IN58
LIMIT SWITCH ASSEMBLY					
	Limit switch Assembly	DRCN03377-01	1	VDR	IN58
SHUTTER ACTUATING CAM					
	Shutter Actuating Cam	VDRK00084-02	2	VDR	IN58
IP SHEET					
	IP Sheet Assembly	VDRK00072-02	1	VDR	IN58
AUXILIARY SWITCH					
	Auxiliary switch S11	AGSH32000-05	1	VDR	IN58
	Auxiliary switch S12	AGSH32000-01	1	VDR	IN58

HVX - ROF CB - 12kV,40kA,800 & 1250A

Item Identification	Variants	Part code	Qty Per VCB (no)	Unit Price	Plant Name	Plant code
EQUIPPED ARMS ASSEMBLY						
	Finger Type upto 1250A	VDRK00327-01	12	2215	VDR	IN58
	Bus bar 60 x 10MM for Top Stem	VDRK00004-01	3	7128	VDR	IN58
	Bus bar 60 x 10MM for Bottom Stem	VDRK00001-01	3	4448	VDR	IN58
	Bus bar 60 x 15MM for Top Stem	DRCN03490-03	3	12304	VDR	IN58
	Bus bar 60 x 15MM for Bottom Stem	VDRK00017-01	3	9040	VDR	IN58
	Insulating Hood for Bottom Arm	DRC007667-01	3	1050	VDR	IN58
VACUUM INTERRUPTER						
	12kV-40kA-800A & 12kV-40kA-1250A	VDRK00011-01	3	124653	VDR	IN58
FLOOR ROLLING TROLLEY						
	Breaker floor Rolling Wheel	MVIA00054-01	4	4032	VDR	IN58
	Axle For Wheel	MVIK00066-01	4	500	VDR	IN58
	Scrap Earthing Assembly	MVIG00143-01	1	550	VDR	IN58
RACKING TROLLEY						





Item Identification	Variants	Part code	Qty Per VCB (no)	Unit Price	Plant Name	Plant code
	Racking Trolley Assembly	VDRG00199-01	1	27888	VDR	IN58
MECHANISM						
	Primary Shaft	AGSH36730-12	1	141500	VDR	IN58
	Bearing Block	AGSH30411-02	1	18105	VDR	IN58
	Spur Gear	VDRP00020-01	1	9017	VDR	IN58
	Operation Counter	VDRP00021-01	1	843	VDR	IN58
	Ramphook	VDRP00022-01	1	1856	VDR	IN58
	Glide	AGSH30469-01	1	2164	VDR	IN58
	Main Gear	AGSH30481-01	1	23261	VDR	IN58
	Spring Drum	AGSH30270-02	1	46775	VDR	IN58
	Cam Disc (Right)	AGSH30276-01	3	10159	VDR	IN58
	Cam Disc (Left)	AGSH30277-01	2	10159	VDR	IN58





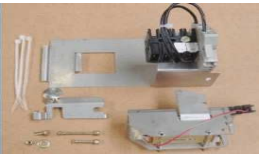
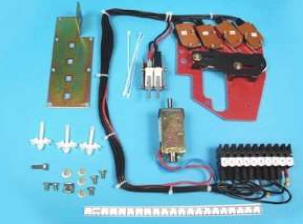
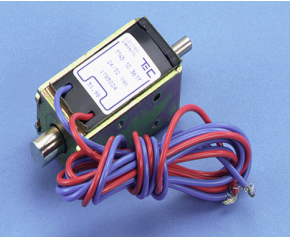

RM6 upto 36 kV









Ring Main Unit





RM6

Item Identification	Variants	Reference
OPERATING MECHANISM		
	<ul style="list-style-type: none"> • Isolator / Switch 	51193845FA
	<ul style="list-style-type: none"> • D/B Circuit-breaker 	51193845FC
D/B CIRCUIT- BREAKER UNDERVOLTAGE COIL KIT		
	<ul style="list-style-type: none"> • D/B Circuit-breaker Undervoltage Coil Kit 24 Vcc/Vdc • D/B Circuit-breaker Undervoltage Coil Kit 48 - 60 Vcc/Vdc • D/B Circuit-breaker Undervoltage Coil Kit 110-125 Vcc/Vdc and 120 Vca/Vac • D/B Circuit-breaker Undervoltage Coil Kit 220 Vcc/Vdc and 220 Vca/Vac 	AAV29672 AAV29673 AAV29676 AAV29678
OPENING COIL KIT		
	<ul style="list-style-type: none"> • D/B Circuit-breaker Trip Coil Kit 24 Vcc/Vdc • D/B Circuit-breaker Trip Coil Kit 48 - 60 Vcc/Vdc • D/B Circuit-breaker Trip Coil Kit 127 Vcc/Vdc • D/B Circuit-breaker Trip Coil Kit 110 Vcc/Vdc - 220 Vca/Vac • D/B Circuit-breaker Trip Coil Kit 220 Vcc/Vdc - 380 Vca/Vac 	51009541FA 51009542FA 51009543FA 51009544FA 51009545FA
CLOSING / TRIPPING COIL		
	<ul style="list-style-type: none"> • 24VDC • 48VDC • 127VAC • 110VDC/220VAC • 220VDC/380VAC 	SPK0008SM6 SPK0009SM6 SPK0010SM6 SPK0011SM6 SPK0012SM6
MOTORIZATION KITS		
	<ul style="list-style-type: none"> • Switch Motorization Block 24 Vcc/Vdc • Switch Motorization Block 48 Vcc/Vdc • Switch Motorization Block 60 Vcc/Vdc • Switch Motorization Block 110 Vcc/Vdc • Switch Motorization Block 125 Vcc/Vdc • Switch Motorization Block 220 Vcc/Vdc • Switch Motorization Block 110 -127 Vca/Vac 50 Hz • Switch Motorization Block 220 - 230 Vca/Vac 50 Hz • Switch Motorization Block 110 - 127 Vca/Vac 60 Hz • Switch Motorization Block 220 - 230 Vca/Vac 60 Hz 	51008240FA 51008241FA 51008242FA 51008243FA 51008244FA 51008249FA 51008245FA 51008246FA 51008247FA 51008248FA
	<ul style="list-style-type: none"> • Circuit-breaker Motorization Block 24 Vcc/Vdc • Circuit-breaker Motorization Block 48 Vcc/Vdc • Circuit-breaker Motorization Block 60 Vcc/Vdc • Circuit-breaker Motorization Block 110 Vcc/Vdc • Circuit-breaker Motorization Block 125 Vcc/Vdc • Circuit-breaker Motorization Block 220 Vcc/Vdc 	51009476FA 51009477FA 51009478FA 51009479FA 51009480FA 51009485FA

Item Identification	Variants	Reference
	<ul style="list-style-type: none"> • Circuit-breaker Motorization Block 110 -127 Vca/Vac 50 Hz 	51009481FA
	<ul style="list-style-type: none"> • Circuit-breaker Motorization Block 220 - 230 Vca/Vac 50 Hz 	51009482FA
	<ul style="list-style-type: none"> • Circuit-breaker Motorization Block 110 - 127 Vca/Vac 60 Hz 	51009483FA
	<ul style="list-style-type: none"> • Circuit-breaker Motorization Block 220 - 230 Vca/Vac 60 Hz 	51009484FA
MOTOR FOR MOTORIZED MECHANISM		
	<ul style="list-style-type: none"> • 24 Vcc/Vdc 	51193931FA
	<ul style="list-style-type: none"> • 48 - 60 Vcc/Vdc 	51193931FB
	<ul style="list-style-type: none"> • 110-125Vcc/Vdc and 110-127 Vca/Vac 50/60Hz 	51193931FC
	<ul style="list-style-type: none"> • 220-230 Vcc/Vdc and 220-230 Vca/Vac 50/60Hz 	51193931FE
BLOCK DIAGRAM FRONT PLATE FOR MOTORIZATION (TO BE OFFERED ALONG WITH MOTORIZATION KITS)		
	<ul style="list-style-type: none"> • Block Diagram Front Plate for Motorised D/B Circuit-breaker NE - D/B 	51194950FH
	<ul style="list-style-type: none"> • Block Diagram Front Plate for Motorised D/B Circuit-breaker DE - D/B 	51194950FJ
	<ul style="list-style-type: none"> • Block Diagram Front Plate for Motorised D/B Circuit-breaker NE - D/B-I 	51194950FG
	<ul style="list-style-type: none"> • Block Diagram Front Plate for Motorised D/B Circuit-breaker NE - I-D/B-I/ with keylocks 	51194950FA
	<ul style="list-style-type: none"> • Block Diagram Front Plate for Motorised D/B Circuit-breaker RE - I-D/B-I / with keylocks 	51194950FB
	<ul style="list-style-type: none"> • Block Diagram Front Plate for Motorised D/B Circuit-breaker NE - D/B-I-D/B-I / with keylocks 	51194950FE
	<ul style="list-style-type: none"> • Block Diagram Front Plate for Motorised D/B Circuit-breaker RE - D/B-I-D/B-I /with keylocks 	51194950FF
	<ul style="list-style-type: none"> • Block Diagram Front Plate for Motorised D/B Circuit-breaker NE – I-I-D/B-I / with keylocks 	51194950FC
<ul style="list-style-type: none"> • Block Diagram Front Plate for Motorised D/B Circuit-breaker RE - I-I-D/B-I 	51194950FD	
SIGNALLING KIT		
	<ul style="list-style-type: none"> • I Switch Position Indication 	51008250FA
	<ul style="list-style-type: none"> • Circuit-breaker Position Indication 	51009486FA
	 <ul style="list-style-type: none"> • CB Fault Tripping Indication 	51009574FA
 <ul style="list-style-type: none"> • Limit Switch - Motor Disabled when CB Trips 	51009573FA	
LOCKING KITS		
• RONIS LOCK KIT		
	<ul style="list-style-type: none"> • Adaptation of a Keylock Device with RONIS Lock R1 Type Switch 	51008258FA
	<ul style="list-style-type: none"> • Adaptation of a Keylock Device with RONIS Lock R2 Type Switch 	51008260FA
	<ul style="list-style-type: none"> • Adaptation of a Keylock Device with RONIS Lock R1 Type CB Manual 	51192729FA
	<ul style="list-style-type: none"> • Adaptation of a Keylock Device with RONIS Lock R1T Type CB Manual 	51194144FA
	<ul style="list-style-type: none"> • Adaptation of a Keylock Device with RONIS Lock R2 Type CB Manual 	51192731FA
	<ul style="list-style-type: none"> • Adaptation of a Keylock Device with RONIS Lock R6 Type CB Manual 	51192733FA
	<ul style="list-style-type: none"> • Adaptation of a Keylock Device with RONIS Lock R7 Type CB Manual 	51192735FA
	<ul style="list-style-type: none"> • Adaptation of a Keylock Device with RONIS Lock R8 Type CB Manual 	51192737FA
	 <ul style="list-style-type: none"> • Adaptation of a Keylock Device with RONIS Lock R1 Type CB Motor 	51193017FA
	<ul style="list-style-type: none"> • Adaptation of a Keylock Device with RONIS Lock R1T Type CB Motor 	51194146FA
	<ul style="list-style-type: none"> • Adaptation of a Keylock Device with RONIS Lock R2 Type CB Motor 	51193019FA

Item Identification	Variants	Reference	
	<ul style="list-style-type: none"> Adaptation of a Keylock Device with RONIS Lock R6 Type CB Motor 	51193021FA	
	<ul style="list-style-type: none"> Adaptation of a Keylock Device with RONIS Lock R7 Type CB Motor 	51193023FA	
	<ul style="list-style-type: none"> Adaptation of a Keylock Device with RONIS Lock R8 Type CB Motor 	51193025FA	
• PROFALUX KIT			
	<ul style="list-style-type: none"> Adaptation of a Keylock Device with PROFALUX Lock R1 Type Switch 	51008259FA	
	<ul style="list-style-type: none"> Adaptation of a Keylock Device with PROFALUX Lock R2 Type Switch 	51008261FA	
	<ul style="list-style-type: none"> Adaptation of a Keylock Device with PROFALUX Lock R1 Type CB Manual 	51192730FA	
	<ul style="list-style-type: none"> Adaptation of a Keylock Device with PROFALUX Lock R1T Type CB Manual 	51194145FA	
	<ul style="list-style-type: none"> Adaptation of a Keylock Device with PROFALUX Lock R2 Type CB Manual 	51192732FA	
	<ul style="list-style-type: none"> Adaptation of a Keylock Device with PROFALUX Lock R6 Type CB Manual 	51192734FA	
	<ul style="list-style-type: none"> Adaptation of a Keylock Device with PROFALUX Lock R7 Type CB Manual 	51192736FA	
	<ul style="list-style-type: none"> Adaptation of a Keylock Device with PROFALUX Lock R8 Type CB Manual 	51192738FA	
	<ul style="list-style-type: none"> Adaptation of a Keylock Device with PROFALUX Lock R1 Type CB Motor 	51193018FA	
	<ul style="list-style-type: none"> Adaptation of a Keylock Device with PROFALUX Lock R1T Type CB Motor 	51194147FA	
	<ul style="list-style-type: none"> Adaptation of a Keylock Device with PROFALUX Lock R2 Type CB Motor 	51193020FA	
	<ul style="list-style-type: none"> Adaptation of a Keylock Device with PROFALUX Lock R6 Type CB Motor 	51193022FA	
	<ul style="list-style-type: none"> Adaptation of a Keylock Device with PROFALUX Lock R7 Type CB Motor 	51193024FA	
	<ul style="list-style-type: none"> Adaptation of a Keylock Device with PROFALUX Lock R8 Type CB Motor 	51193026FA	
	KIT MITOP CDE D		
		<ul style="list-style-type: none"> MITOP Trip unit 	51193845FE
RELAY			
	<ul style="list-style-type: none"> Relays VIP 35 	03143046FA	
	<ul style="list-style-type: none"> Relays VIP 300 LL 	03143428FA	
FLAIR 22D FAULT PASSAGE INDICATOR (FPI)			
	<ul style="list-style-type: none"> FLAIR 22D Lithium Dua Fault Passage Indicator(FPI) 	EMS58352	
CURRENT TRANSFORMER			
	<ul style="list-style-type: none"> VIP-300 LL CT (200/1) 	51007003F0	
	<ul style="list-style-type: none"> VIP-300 LL CT (1200/1) 	51007004F0	
	<ul style="list-style-type: none"> VIP-35 CT (500-200/1) 	51007005F0	
SOLID CORE CT (2200 TURNS) FOR FPI			
	<ul style="list-style-type: none"> CT For FPI 	59925	
VPIS KIT			
	<ul style="list-style-type: none"> VPIS Standard : 3.3 to 7.7 kV 	BBV14380	
	<ul style="list-style-type: none"> VPIS Standard : 8.8 to 16 kV 	BBV14381	

Item Identification	Variants	Reference
 <p>Voltage indicator</p>	<ul style="list-style-type: none"> • VPIS Standard : 16.1 to 23 kV 	BBV14382
	<ul style="list-style-type: none"> • VPIS Voltage output : 3.3 to 7.7 kV 	BBV14027
	<ul style="list-style-type: none"> • VPIS Voltage output : 8.8 to 16 kV 	BBV14028
	<ul style="list-style-type: none"> • VPIS Voltage output : 16.1 to 23 kV 	BBV14029
HEATING RESISTANCE		
	<ul style="list-style-type: none"> • Heat Resistor for I Switch Operating Mechanism 	51191956FA
	<ul style="list-style-type: none"> • Heat Resistor for D/B Circuit-breaker Operating Mechanism 	51191956FC
OPERATING LEVER		
	<ul style="list-style-type: none"> • RM6 Operating Handle Big Size 	3725708
	<ul style="list-style-type: none"> • RM6 Operating Handle Small Size 	1796452

NOTE :- Please refer selection guide from speed for interlocking kits
Please refer speed for replacement manual of all references.

Life Is On



Schneider Electric Infrastructure Limited

Milestone 87, Vadodara-Halol Highway, Village Kotambi, Post office Jarod, Vadodara - 391 510, Gujarat, India
Tel.: +91 (0) 2668 663150 Fax: +91 (0) 2668 663260
www.schneider-electric.com

Customer Care Centre

Monday-Saturday, 9 a.m. to 8 p.m.

Toll-free numbers: 1800 425 4272, 1800 103 0011

Email: customercare.in@schneider-electric.com

For more information, visit our website at:

www.schneider-electric.co.in